

Specification Guide

Offering a complete solution[®]

Wide range of white, coloured and foiled woodgrain PVC-UE roofline boards, window trims and cladding planks.

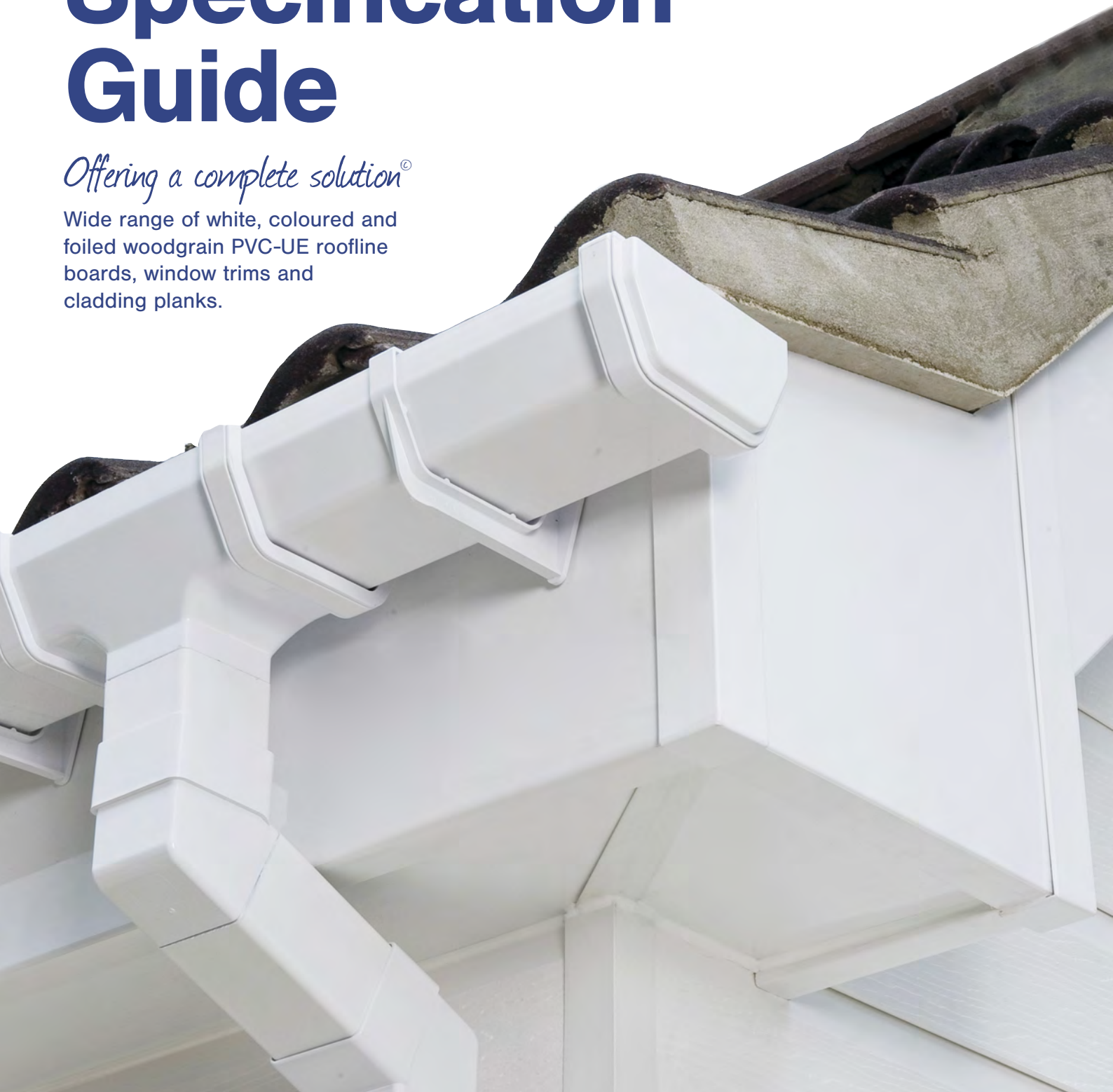

Fascias | Soffits | Cladding | Windowboards | Architraves



www.kbp.co.uk

KESTREL[®]
rely on it



	3 Benefits of Kestrel PVC-UE & PVC-U
	4 The Kestrel Range and Colours

Roofline	5 Fascia Installation Details
	6 Fascia Installation Details
	7 Fascia Installation Details
	8 Bargeboard Installation Details
	9 Soffit Installation Details
	10 Roofline Range & Dimensions
	11 Roofline Range & Dimensions
	12 Boxed End Installation Details
	13 Roofline Ventilation & Provision of Ventilation
	14 Roofline Ventilation
	15 Soffit Range
	16 Typical Jointing Details
	17 Typical Jointing Details
	18 Working with Woodgrain Products: Roofline
19 Fixing Summary - Roofline	

Cladding	20 White Cladding Installations
	21 White Cladding Installations
	22 White Cladding Installations
	23 White Cladding Installations
	24 White Cladding Installations
	25 White Cladding Installations
	26 Working with Woodgrain Products: Cladding
	27 Fixing Summary - Cladding
	28 Kavex Textured Cladding Installations
	29 Kavex Textured Cladding Installations
	30 Kavex Textured Cladding Installations
31 Fixing Summary - Kavex Cladding	

Windowboards & Trims	32 Internal Applications for Kestrel Products
	33 Windowboards & Trims
	34 Window Board Range
	35 Trims Range

Technical	36 10 Most Frequently Asked Questions
	37 Product Characteristics
	38 Product Characteristics
	39 Fixing Summary - General

Benefits of Kestrel PVC-UE & PVC-U

Kestrel's popularity in the new build, specification, architectural and refurbishment sector stems from its product reliability and wide acceptance amongst the trade and the general public.

Refurbishment programmes by housing associations and local authorities acknowledge Kestrel products as the route to lower maintenance costs.

Key Features

Flexibility

A wide range of designs and styles to suit virtually every commercial, industrial and domestic application. With flexibility of application built in at every stage.

Durability

Long-lasting, reliable products that will not rot, split, warp or crack and that are designed to resist the elements.

Practicality

Never needs painting or preserving and will stay looking good for years to come. Easy to specify and simple to install.

Good-looking

A wide variety of colours and finishes to choose from with designs for every application.

Quality - BS EN ISO 9001

The company has a Quality Management System approved by the British Standards Institute to BS EN ISO 9001 (FM 605711).



Environmental - BS EN ISO 14001

The company has an Environmental Management System approved by the British Standards Institute to BS EN ISO 14001 (EMS 605712).



Responsible Sourcing - BES 6001

The company has a Responsible Sourcing System approved by the British Standards Institute to BES 6001 (BES 605713).



Recovinyl

Recovinyl facilitates the collection and recycling of PVC post-consumer waste from the construction and demolition sector.



Product Guarantees

Kestrel's white products are guaranteed for 20 years as standard or can be extended to 35 years through our Approved Installer Scheme. All foiled profiles are guaranteed for 10 years provided that approved installation and maintenance instructions are followed. Copies of the guarantees which relate to white and foiled products are available from customer services on 08702 406107.



Vinyl Plus

Eliminating the lead content in PVC has been a matter of particular concern for responsible manufacturers in our industry. As recommended by the European Commission, UK Government and the PVC industry's Vinyl Plus initiative, some suppliers have already made the switch. Kestrel is among those leading the way. In fact, we believe we were the first in the UK to offer calcium organic core and calcium organic skin in our PVC-UE. As well as future proofing the product for our customers in case new legislation on material usage does come into play, we are also doing what we can now in the global drive for environmental protection.



BIM Store

Some of Kestrels' specification products are now available to browse and download from the BIM Store.



Fastrack Cad

Fastrack CAD is an online CAD database which gives architects and specifiers the opportunity to download DXF or DWG files. Kestrel's library of CAD drawings which is available on-line and can be accessed and downloaded by visiting www.kbp.co.uk



NBS

The National Building Specification (NBS) is a library of clauses that can be selected and edited and used to produce project specifications. Kestrel's NBS information is available on-line and can be accessed through www.thenbs.com



CE Marking

Kestrel PVC-UE cladding is covered by a harmonised European standard - BS EN 13245:2008. A declaration of performance to this standard is available and the product packaging carries a 'CE marking' label.



Kestrel PVC-UE & PVC-U extruded products are ideally suited for both domestic and commercial applications. They perform better in use than traditional alternatives, are quick and easy to install, and are virtually maintenance-free. When calculating whole-life costs, Kestrel's products invariably offer a more practical and lower cost option.



Fascia and Capping boards

Kestrel's extensive range of Square Leg, Flush, Ogee and Bullnosed fascia boards provide the complete solution to every roofline application. Available in three whites and a selection of foiled colours.

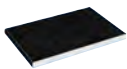

Soffit/General purpose boards & accessories

Available in widths from 100mm to 600mm, in 5m lengths, three whites and wide range of foiled colours. Now also available with two finished edges.



Preventilated Soffit

Available in Kestrel whites and woodgrain, the preventilated soffit boards incorporate integral air slots giving 10mm or 25mm continuous ventilation. Boards are 9mm thick and are available in widths up to 600mm.

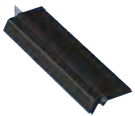

Ventilation and Eaves protection Systems

An over fascia system which provides an alternative method of roof void ventilation. Simple to install with easy fit clipping joints, the system is available in Black. Circular soffit vents are also available, in White and all three solid colours.



Window Boards

A variety of shapes, sizes and finishes and available to suit all domestic and commercial window applications.



Finishing Trims / Architraves

Kestrel's wide variety of finishing trims / architraves are available in a selection of colours, shapes and sizes to suit all window and internal finishing applications.



Cladding systems

Kestrel's cladding systems can be fixed vertically, horizontally or diagonally and are available in two styles: Shiplap with 150mm coverage and V-joint with 100mm coverage. The system is available in all white and woodgrain colours.



Kavex Textured Cladding

Kestrel's textured claddings are available in two styles: Shiplap with 150mm or 300mm coverage and Featheredge with 270mm coverage, both come with a full range of accessories. They are available in White, Sand, Cream, Light Blue and Light Grey providing an effective yet stylish external cladding solution.



Fixings

A selection of sizes is available in a variety of colours to suit all applications.







Colours

Kestrel has been at the forefront of product development in the PVC-UE and PVC-U building products sector for the last twenty years. Our innovations have helped to develop new markets and to offer both customer and consumer a greater degree of choice. Keeping abreast of consumer trends for colours and textures is also key to meeting demand.

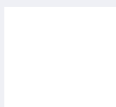
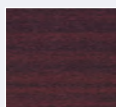
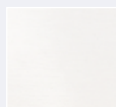
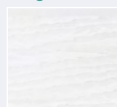
The current Kestrel range includes:

- Solid Colours:**
- Brilliant White • Dove White
- Woodgrain Foils:**
- Mahogany • Blackgrain
 - Sherwood • Rosewood
- Premiergrain Foils:**
- Whitegrain
 - Creamgrain • Irish Oak
 - Anthracite Grey
- Textured solid colours:**
- White • Cream
 - Sand • Light Blue
 - Light Grey

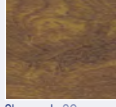
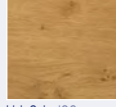
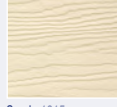
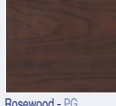
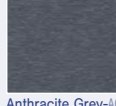
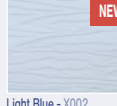
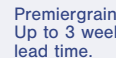
For a colour-matched product sample, please contact our samples department on 01724 400 485 or email info@kestrelbce.co.uk

Whites	Woodgrains Foils	Premiergrains	Kavex Range
 Brilliant White - BW	 Mahogany - WG	 Whitegrain - WHG	 White - W
 Dove White - DW	 Blackgrain - BG	 Creamgrain - CRG	 Cream - 9001
	 Sherwood - SG	 Irish Oak - IOG	 Sand - 1015
	 Rosewood - PG	 Anthracite Grey-AGG	 Light Blue - X002
		 Premiergrains: Up to 3 week lead time.	 Light Grey - 7035

Typical Eaves Details

K16 Fascia & 9mm Vented Soffit

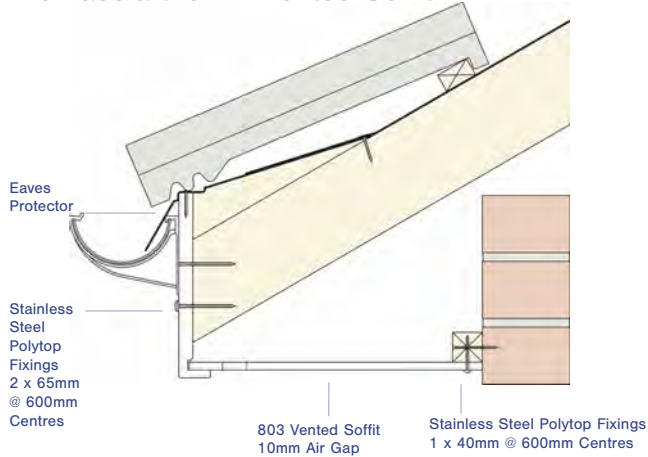

K22 Fascia & 9mm Vented Soffit

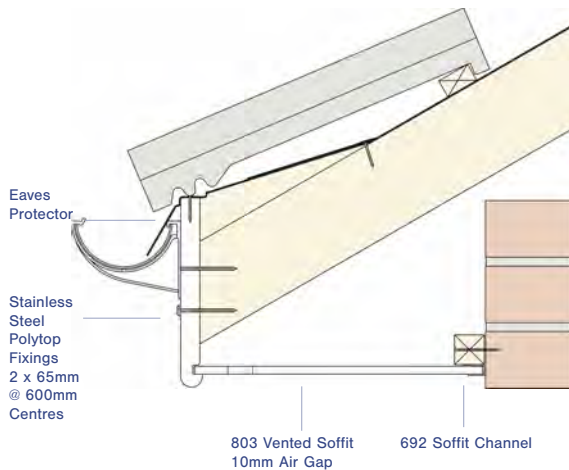

KB16 Fascia & 9mm Vented Soffit

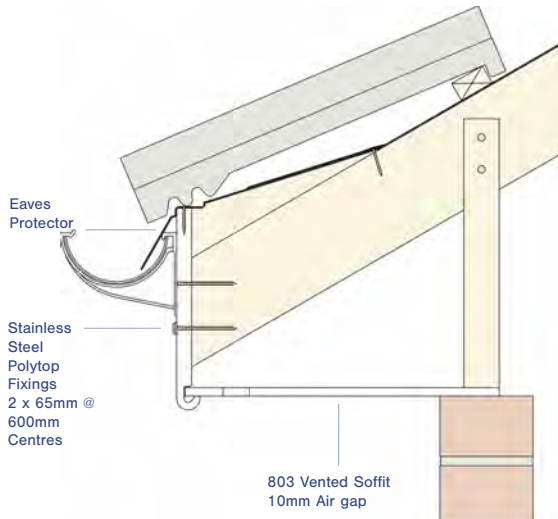

This section of the guide is intended to provide you with a brief overview of the popular products in Kestrel's Roofline range, where they can be used and the main criteria for installation.

Pre-Installation Considerations

Preparation:

- All access and works to comply with current and relevant Health & Safety and Construction Design Management Regulation recommendations
- Clear work area in-line with best practice before starting work, ensuring safe scaffolding access is available
- Remove first row of roof tiles where necessary
- Remove all existing fascia / soffit materials
- Replace any un-sound / rotten timber or felt and treat rafter ends with preservative
- Maintain air path for roof ventilation

Installation considerations

Installation considerations are intended to provide you with need-to-know information for the core processes of product installation.

They are not intended as an exhaustive installation guide. The information presented will provide you with a valuable resource when assessing how best to use our products in your selected application.

Fascia

Fit directly to rafter ends using polytop nails, 2 per fixing centre max 600mm centres - 65mm nails. Austenitic stainless steel (Grade A4 BS EN ISO 3506-1 : 2009). Fascia is capable of load bearing in relation to light weight gutters and the first row of roof tiles (Eaves Tiles).

Expansion gaps of 5mm per board end must be allowed for during installation.

Cover joints and Corners to be secured using low modulus neutral cure silicone. BS5889 Type A.

Gutter brackets to be secured directly into the board using stainless steel screws - 10 gauge x 25mm long (parallel thread form).

All Kestrel fascia boards 16mm and over are capable of load bearing and may be used in new-build or refurbishment.

018 Fascia & 100mm V-Joint Cladding - Vented

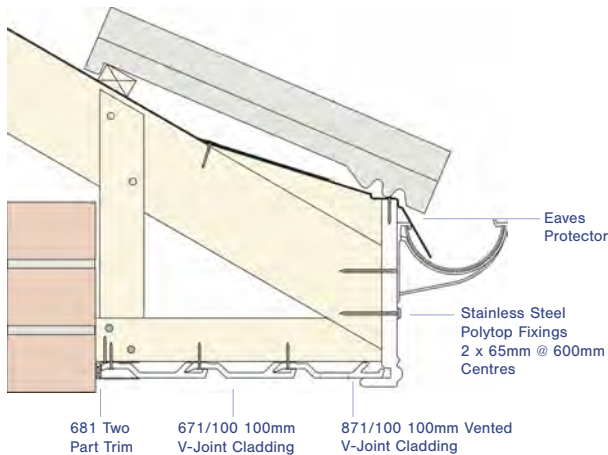

Tongue and Groove Cladding

Shi lap and Open-V cladding planks may also be used as soffit. The Open-V version is also available in a pre-ventilated form. Vented cladding planks have a 12.5mm air gap which permit 25mm continuous ventilation to be achieved via the use of two rows of vented product. Cladding planks are secured using 30mm cladding pins.

- Joints for K22, K16, KB16 & 605 are available in 600mm lengths in addition to shorter standard lengths.
- When using 018 as a bargeboard the box end piece will need to be packed out to prevent the Ogee form of the bargeboard standing proud of the box end piece.

KF16 & 803 Timber Frame Detail

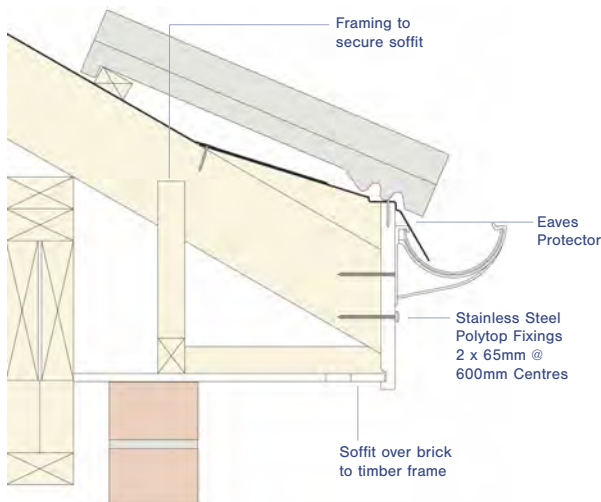

Timber Frame

When fitting to timber frame project, be aware the soffit needs to be large enough to carry over the top of the brickwork line, back to the timber frame. Soffit widths should not exceed 300mm without additional support.

K16 & 803 Fascia Detail for Extreme Winters

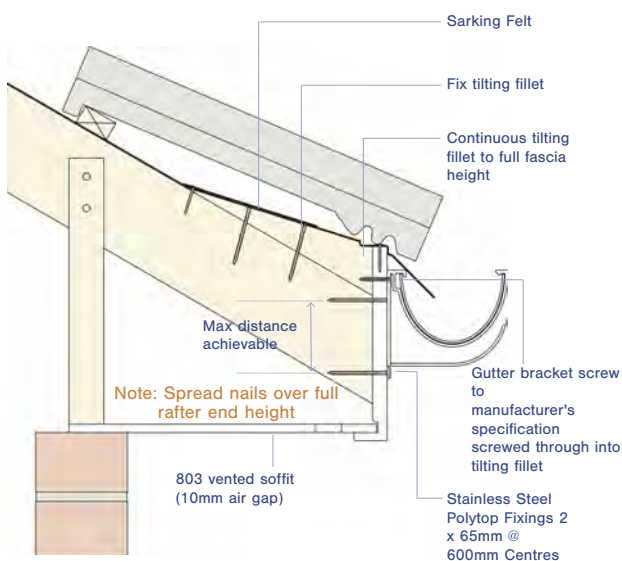

Extreme Winter Fitting Guidelines

- A continuous tilting fillet must be used.
- The fillet provides screw retention for the gutter brackets and support to the top of the fascia. It should be securely nailed into the top of each rafter
- Plastic headed, 65mm long, austenitic stainless steel (grade A4) nails, are used to fix the fascia by nailing directly into rafter ends.
- 2 fixings must be used at each fixing centre, with a maximum distance of 600mm between centres.
- Fixings should utilise as much of the height of the rafter end as possible, taking care not to split the timber and ensuring full depth nail engagement.
- Gutter bracket screws should be fixed through the PVC-UE fascia into the continuous tilting fillet.
- Gutter specification and fixings should be obtained from the gutter system manufacturer.

When considering the overall performance of the eaves area of a roof, it is important to include the roof design, the components and ultimately the imparted load from rain, snow and wind. The above guidance has been compiled to aid the roof designer in obtaining the maximum performance from the PVC-UE fascia element.

Fascia Installation Details

Flat Roof Detail

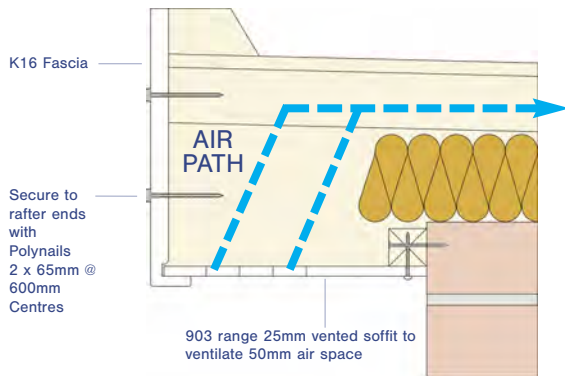

Flat Roof Installation

When fitting to a flat roof area, consideration must be given to allow adequate ventilation above the insulation in order to comply with building regulations. See ventilation section for a full explanation of ventilation requirements.

605 Fascia & 9mm Vented Soffit

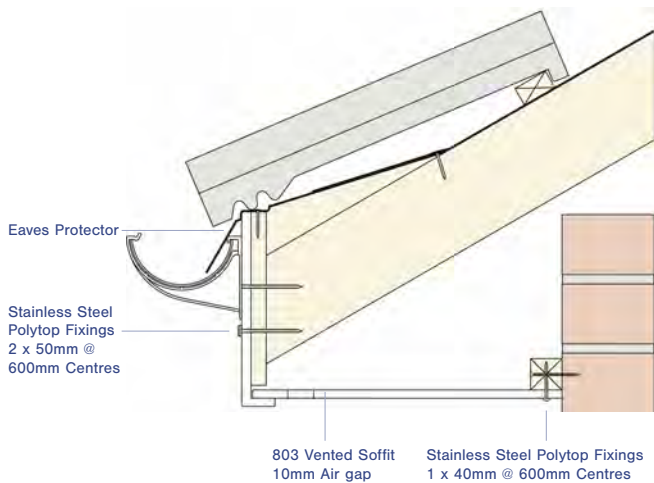

Replacement Projects

Kestrel manufacture several designs of fascia capping boards which can be fitted over the top of existing timber fascias and bargeboards provided these are sound.

Any unsound or insecure timbers or rafter surfaces should be removed and replaced before overcapping.

Fascia capping boards are available in square, bullnose and ogee designs and fit flush to the existing sound fascias or backing boards.

Fascia capping boards also incorporate a return leg to cover the existing fascia and enclose the soffit leaving a neat finish.

All overcapping fascias can also be used for new-build work, but will require a minimum 12mm exterior grade plywood backing board (BS EN 636:2012+A1:2015). (see fixing summary on p19).

K16 Fascia & 9mm Inclined Soffit

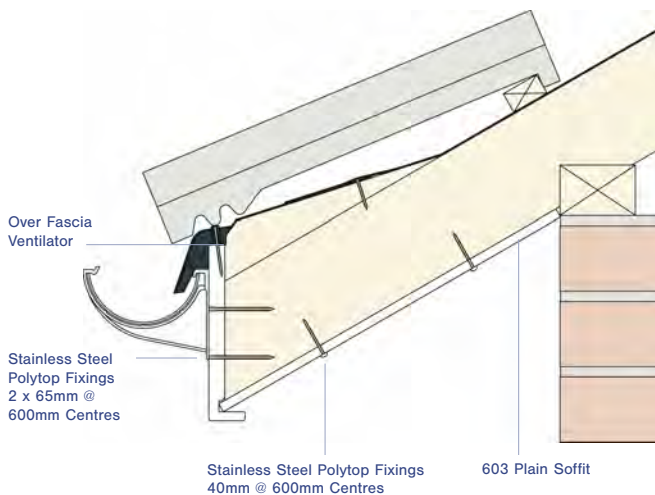

Inclined soffits

In both new-build and replacement situations, K16 or 605 fascias can be used in conjunction with inclined soffit details, as the return leg (36mm) is wide enough to provide support for the soffit board.

Soffits in this situation are normally plain, such as 603, but can be detailed with cladding if desired.

In this instance, the use of over fascia ventilation is recommended as the ventilation slots in pre-ventilated soffits are restricted. Alternatively a soffit with increased ventilation can be selected.

The boards should be fixed to the rafters at not greater than 300mm centres across the soffit width.

Typical Verge Details

K16 - 16mm Bargeboard & Plain Soffit

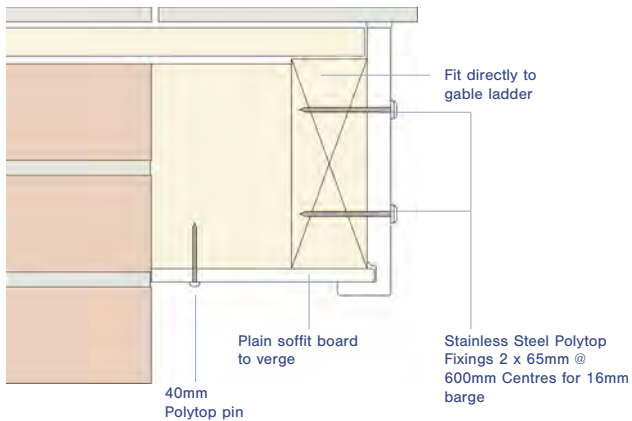

Bargeboard

K16 16mm bargeboard should be installed using 65mm Polytop nails 2 per fixing centre at maximum 600mm centres. Austenitic stainless steel (grade A4 BS EN ISO 3506-1 : 2009).

605 9mm bargeboard should be installed using 50mm Polytop nails 2 per fixing centre at maximum 600mm centres. Austenitic stainless steel (grade A4 BS EN ISO 3506-1 : 2009).

- Boards less than 16mm thick boards are required to be fully supported along their length.

V-Wave and V-Crest being 16mm thick should be installed using 65mm Polytop nails 2 per fixing centre at maximum 600mm centres.

605 - 9mm Bargeboard & No Soffit

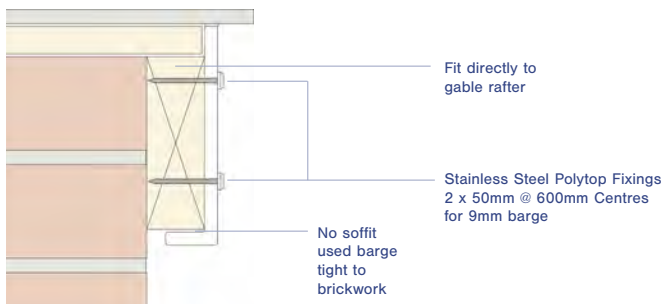

The joint of bargeboards meeting at a ridge should be covered using a cover joint or feature finial and secured using Low Modulus Neutral Cure Silicone

Complementary Ranges

The K16 and 605 are complementary ranges being the same external shape.

This allows the 9mm barge to be used in conjunction with the 16mm fascia for a more cost effective solution.

The K22 and KB16 are also complementary ranges being the same external shape.

This allows the 16mm barge to be used in conjunction with the 22mm fascia, to be a more cost effective solution.

- NB: KB16 barge can be run into a K22 box end piece to create a stepped box end feature.

008 - 8mm Bargeboard to Timber Frame

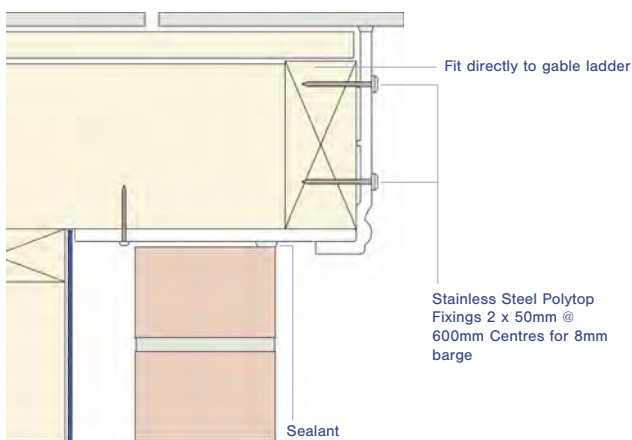

Soffit Installation Details

K16 & Plain Soffit to box end return

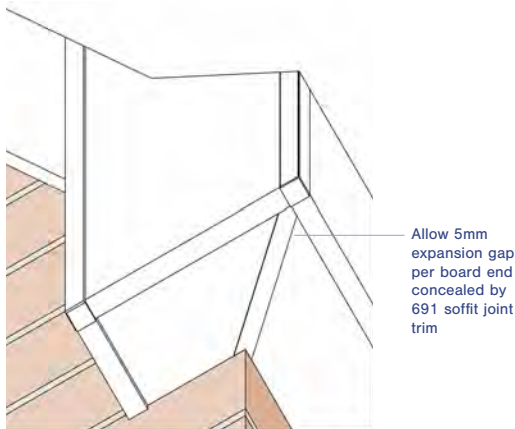

Stainless Steel Polytop Fixings
1 x 40mm @ 600mm Centres

Soffit

Kestrel 9mm soffit boards are available in non-vented versions for use as verge soffit or as eaves soffit when other forms of eaves ventilation are to be used. They are also available in ventilated form and can contribute towards providing the necessary roof space ventilation.

Soffit is secured at maximum 600mm centres to timber using 40mm Polytop pins, alternatively a wall side fix may be achieved using 692 Soffit Channel.

In properties where the outer skin of brickwork is level with the bottom of the fascia board soffit groove, the soffit may be extended over the brickwork and clamped using timber battens secured to the rafter sides.

- Soffit widths should not exceed 300mm without additional support.
- Soffit board fixings should not exceed 300mm across the soffit width.
- H-section trim (691 or 693) is used to join soffit boards.
- A soffit board channel (F trim or J trim) can be used to securely locate the soffit at the wall.
- Soffits can be detailed from standard soffit boards, or Open 'V'-Joint / Shiplap cladding.
- All Open 'V'-Joint and Shiplap cladded soffits should be fully supported and fixed to timber bearers at max 600mm centres along the soffit length
- It is recommended that cladding is detailed when designing wide soffits.
- The appropriate trims must be used in conjunction with cladded soffits (see Cladding section).

Installation

Use Stainless Steel Polytop Fixings 1 x 40mm @ 600mm Centres. Soffit widths should not exceed 300mm without additional support and fixing.

Mitred Soffit Corner

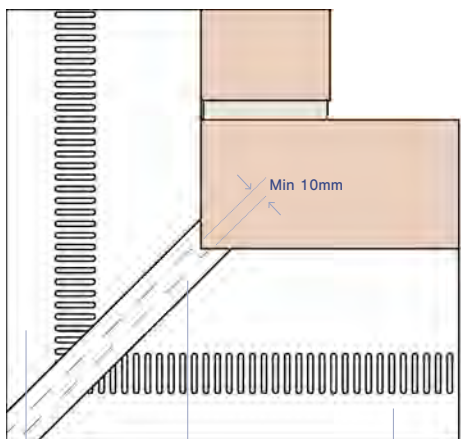

803 Vented Soffit 10mm Air gap Soffit H Section 691 or 693 803 Vented Soffit 10mm Air gap

Straight Soffit Corner

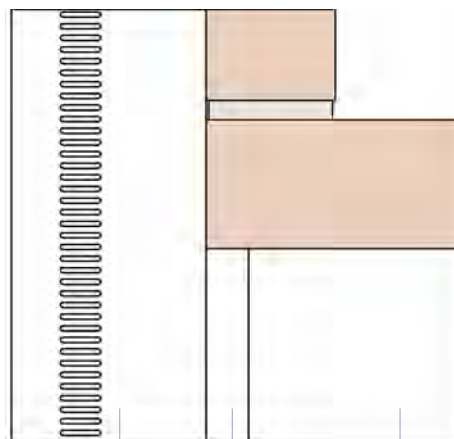

803 Vented Soffit 10mm Air gap Soffit H Section 691 or 693 Plain Soffit

		Code	Dimension X
	K22	K22/150 K22/175 K22/200 K22/225 K22/250 K22/300 K22/355 K22/405	150mm 175mm 200mm 225mm 250mm 300mm 355mm Double Nose 405mm Double Nose
	KB16	KB16/150 KB16/175 KB16/200 KB16/225 KB16/250 KB16/405	150mm 175mm 200mm 225mm 250mm 405mm Double Nose
	K16	K16/150 K16/175 K16/200 K16/225 K16/250 K16/355 K16/405 K16/405/1.25	150mm 175mm 200mm 225mm 250mm 355mm Double Leg 400mm Double Leg 400mm Double Leg
	KF16	KF16/150 KF16/175 KF16/200 KF16/225 KF16/250 KF16/405	150mm 175mm 200mm 225mm 250mm 405mm
	605*	605/100 605/125 605/150 605/175 605/200 605/225 605/250 605/300 605/405 605/450 605/600	100mm 125mm 150mm 175mm 200mm 225mm 250mm 300mm 405mm 450mm 605mm

Roofline Range

		Code	Dimension X
 <p>505</p>	 <p>018</p>	505* 505/150 505/175 505/200 505/225 505/250 505/355 505/405	150mm 175mm 200mm 225mm 250mm 355mm 405mm Double Leg
		018 018/150 018/175 018/200 018/225 018/250 018/405	150mm 175mm 200mm 225mm 250mm 405mm Double Leg
 <p>008</p>	008* 008/150 008/175 008/200 008/225 008/250 008/405	150mm 175mm 200mm 225mm 250mm 405mm Double Leg	
 <p>V-Crest</p>	V-WAVE & V-CREST V-WAVE V-CREST	150mm min. coverage 150mm min. coverage	
		<p>* These products can be used as fascia boards with a minimum 12mm exterior grade plywood backing board.</p>	

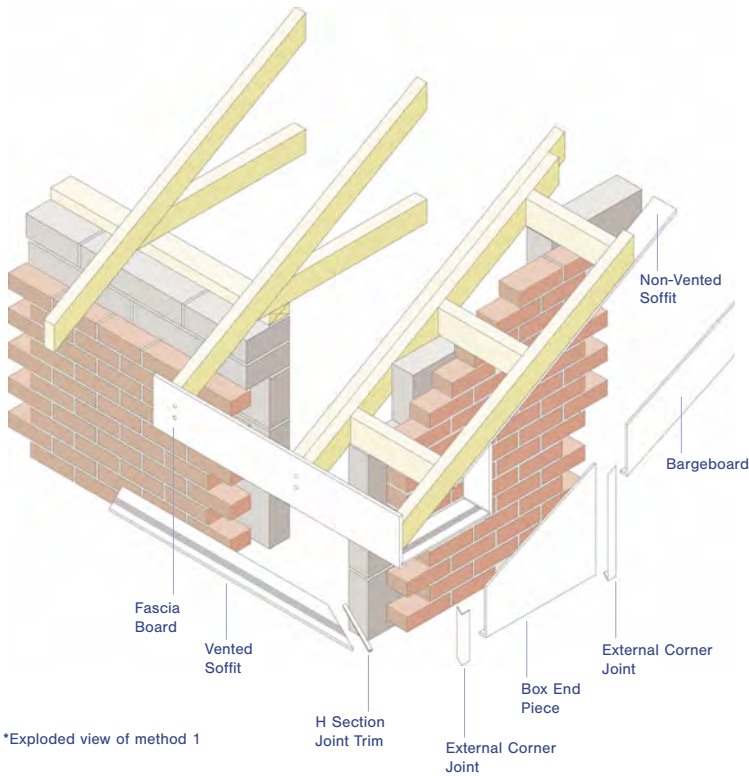

Boxed Ends

To provide a neat and weathertight area at the point where Fascia and Bargeboard meet, it is necessary to construct a box end.

A box end piece is cut from wide Bargeboard material (nominally 405mm) to suit the roof pitch and overhang requirement. When using 605 bargeboard large box end details may be obtained by using the extra wide product of 600mm width.

The soffit forming the base of the box end must match the eaves soffit and is mitred at the joint, using 691 H-section as a jointing trim.

Box ends are supported using a preservative treated timber framework.

Boxed End Methods

The jointing of the bargeboard into the box end piece can be achieved in two ways

Method 1 → Method 1

The Bargeboard is cut plumb directly above the back edge of the box. A corner joint with a piece of one face removed is then used to cover the back corner and Bargeboard/Box end piece joint.

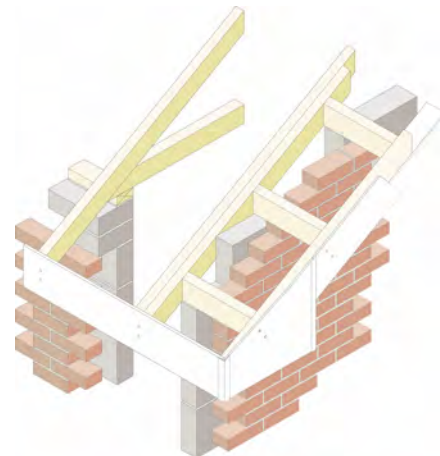
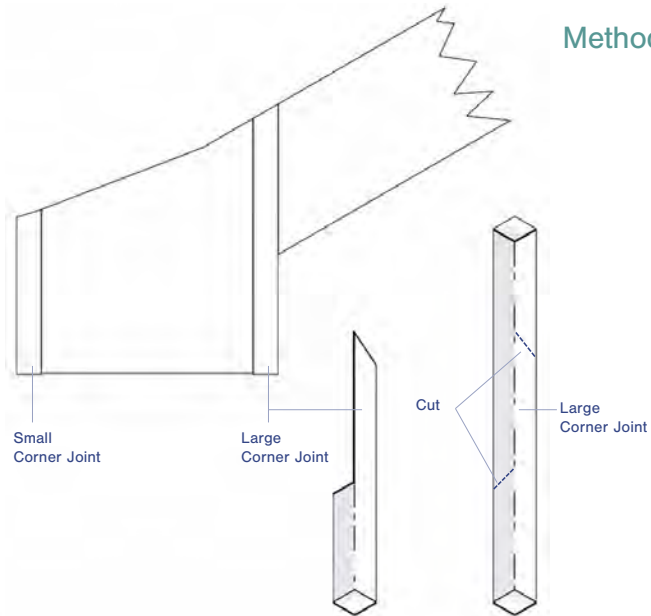

Method 2 → Method 2

The bargeboard is cut perpendicular to its length; the angled joint between the boards being covered by a cover joint with its return leg removed. The bottom edge of the cover joint is then cut to mate with the top edge of the corner joint used to cover the back corner of the box end.

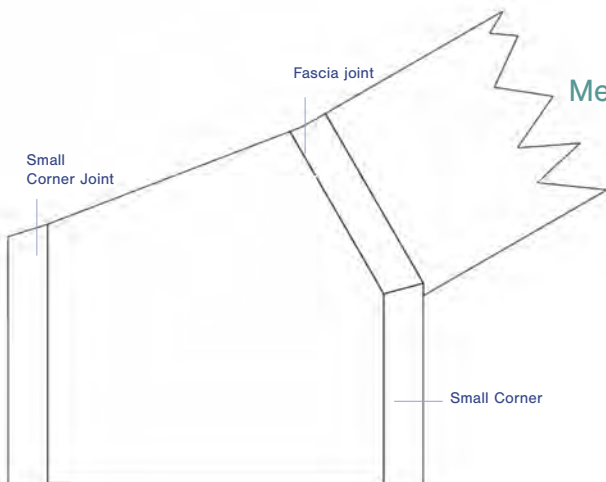

Provision of Ventilation

Cold Roofs

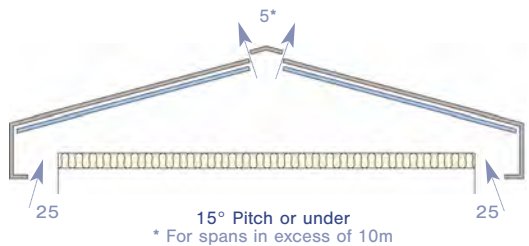
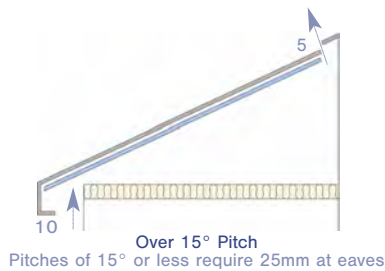
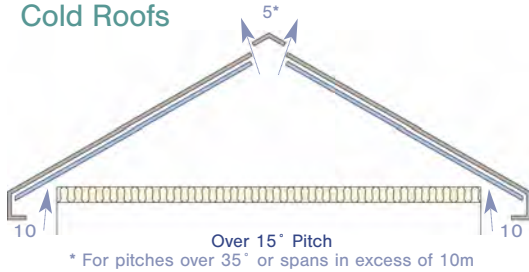

Warm Roofs

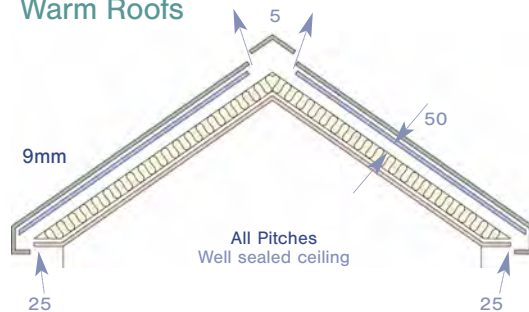

Dimensions in millimetres

Roofline Ventilation

The requirement to ventilate the roof space of a building to protect the building and people who use it from the harmful effects caused by condensation is covered by 'The Building Regulations 2000.'

Guidance on the provision of adequate ventilation is given in Approved Document C2 Resistance to Moisture (2004 edition) and detailed in BS5250: 2011 Code of practice for control of condensation in buildings.

Kestrel provides a comprehensive range of products designed to comply with the requirements of these regulations. (www.kbp.co.uk)

Kestrel 9mm soffit boards are available in non-vented versions for use as verge soffit or as eaves soffit when other forms of eaves ventilation are to be used.

They are also available in ventilated form and will contribute towards providing the necessary roof space ventilation.

These pre-ventilated soffits are available in 10mm air gap up to 600mm wide and 25mm air gap up to 450mm wide.

All soffits are covered by Kestrel's British Board of Agreement Certificate No. 11/4835.

Provision of Ventilation

The illustrations opposite reflect the basic ventilation requirements normally applicable for impermeable underlays (Type HR). For additional information including the use of vapour permeable underlays (Type LR) please refer to BS5250: 2011.

Disc and Strip Ventilators

Kestrel provides circular soffit disc ventilators for eaves ventilation. These are fitted at varying centres, into 70mm diameter holes, to achieve the desired level of ventilation.

Kestrel also provides a continuous ventilator strip for eaves ventilation.

This strip is manufactured from PVC-U in 5m lengths giving ventilation equivalent to a 25mm air gap.

Ventilation Products

803

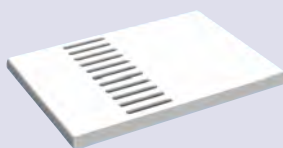

10mm Air Gap

903

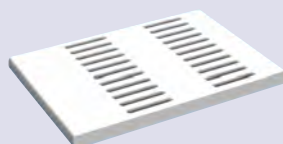

25mm Air Gap

K716

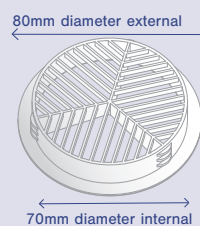

10mm Air Gap = 250mm centres
25mm Air Gap = 100mm centres

662/525

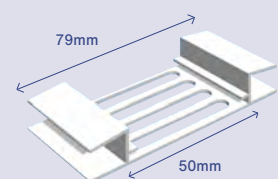

Equivalent 25mm Air Gap

K708 Eaves Protector

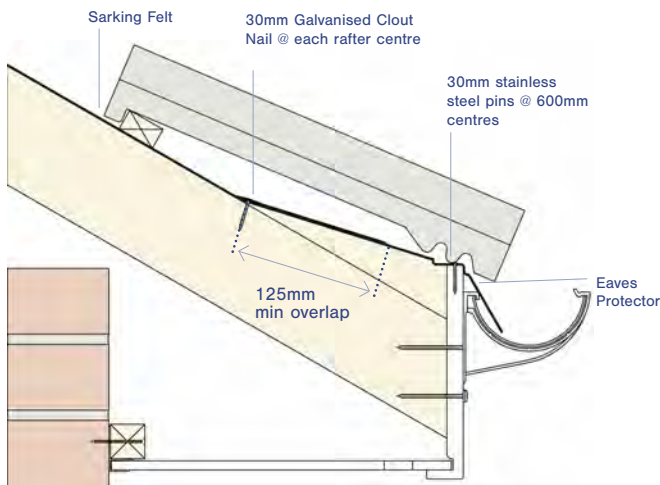

Eaves Protection

The Kestrel Eaves Protector K708 has been designed to provide a long-term solution to the problems associated with eaves decay under the roof, including the degradation of sarking felt and the secondary rotting of rafter timbers and other roof structures.

Available in 1.5m lengths the Kestrel eaves protection profile consists of a durable black pigmented PVC-U profile located between the roof tiles and the PVC-UE fascia system.

Whether used on refurbishment projects or in new-build installations, the traditional sarking felt finishes before the fascia and is lapped over the eaves protector. Therefore it is not exposed to the elements and is not subject to decay.

UNIOFV Over Fascia Ventilator & Eaves Protector

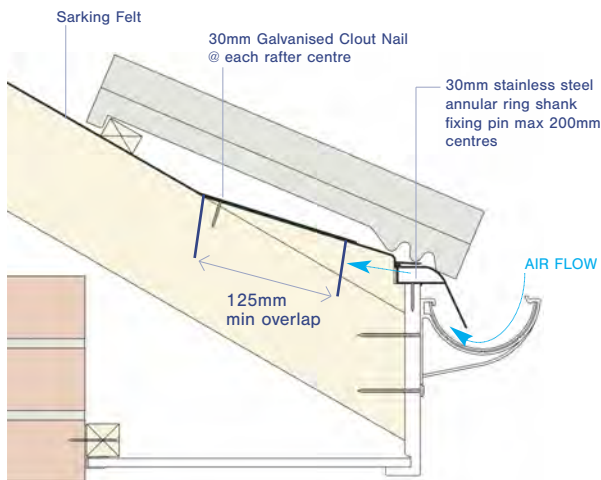

Ventilation and Eaves Protection

A further enhancement of the idea of the eaves protector comes in the form of UNIOFV an eaves protector combined with over fascia ventilation and bird comb. The ventilation of the roof void at eaves level is provided by an upstand on the underside of the eaves protector which sits on the top edge of the fascia board.

The UNIOFV product provides ventilation equivalent to a 10mm continuous slot.

The provision of an integral bird comb provides an effective barrier against bird infiltration into the roof void when using profiled roof tiles. If flat slate tiles are to be used the comb is readily removed.

- The durability and rigidity of the eaves protectors and the load bearing features of Kestrel fascia boards are such that no tilting fillet is needed.

K712 Over Fascia Ventilation Strips

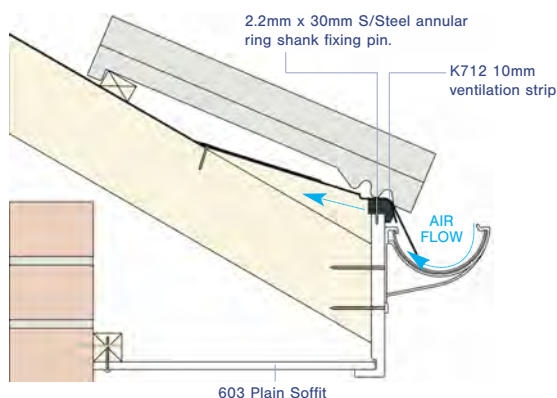

Eaves Ventilation

A simple means of providing ventilation over the fascia is also available in the form of Kestrel K712 over fascia ventilation strips.

The K712 product provides ventilation equivalent to a 10mm continuous slot.

This product is also available as K712/025 to provide ventilation equivalent to a 25mm continuous slot.

As with the UNIOFV, this product is designed to sit directly on top of the fascia board. Fix with 30mm stainless steel cladding pin at every fixing centre.

- Fix the K712 with 30mm stainless steel annular ring shank fixing pin at every fixing centre.
- Fix the K712/025 with 50mm stainless steel annular ring shank fixing pin at every fixing centre.

Soffit Range

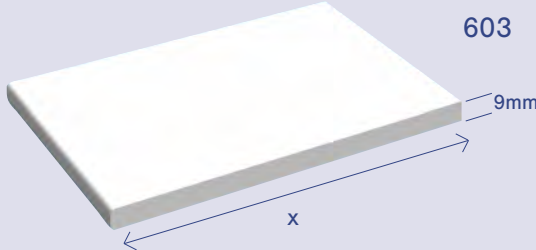
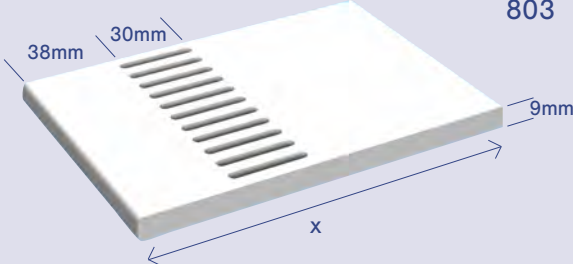
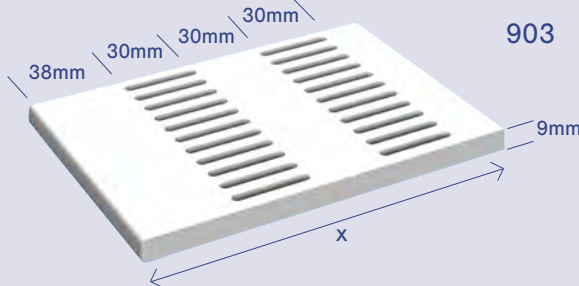
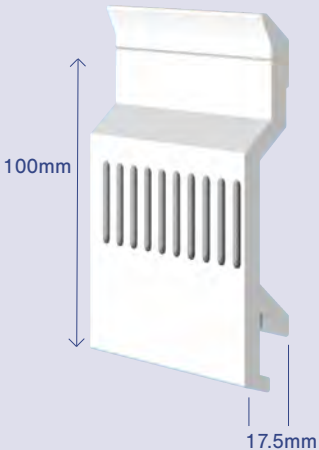
		Code	Dimension X
<p>Non-ventilated Soffit</p>  <p>603</p>		<p>603</p> <p>603/100</p> <p>603/125</p> <p>603/150</p> <p>603/175</p> <p>603/200</p> <p>603/225</p> <p>603/250</p> <p>603/300</p> <p>603/330</p> <p>603/400</p> <p>603/450</p> <p>603/500</p> <p>603/600</p>	<p>100mm</p> <p>125mm</p> <p>150mm</p> <p>175mm</p> <p>200mm</p> <p>225mm</p> <p>250mm</p> <p>300mm</p> <p>325mm</p> <p>400mm</p> <p>450mm</p> <p>500mm</p> <p>600mm</p>
<p>10mm Air Gap Pre-Ventilated Soffit</p>  <p>803</p>			
<p>25mm Air Gap Pre-Ventilated Soffit</p>  <p>903</p>		<p>803</p> <p>803/100</p> <p>803/150</p> <p>803/175</p> <p>803/200</p> <p>803/225</p> <p>803/250</p> <p>803/300</p> <p>803/330</p> <p>803/400</p> <p>803/450</p> <p>803/500</p> <p>803/600</p>	<p>100mm</p> <p>150mm</p> <p>175mm</p> <p>200mm</p> <p>225mm</p> <p>250mm</p> <p>300mm</p> <p>325mm</p> <p>400mm</p> <p>450mm</p> <p>500mm</p> <p>600mm</p>
<p>12.5mm Air Gap Pre-Ventilated Cladding</p>  <p>871</p>		<p>903</p> <p>903/200</p> <p>903/300</p> <p>903/400</p>	<p>200mm</p> <p>300mm</p> <p>400mm</p>
		<p>871</p> <p>Code</p> <p>871/100</p>	<p>Coverage</p> <p>100mm</p>

Soffit Joint Installation

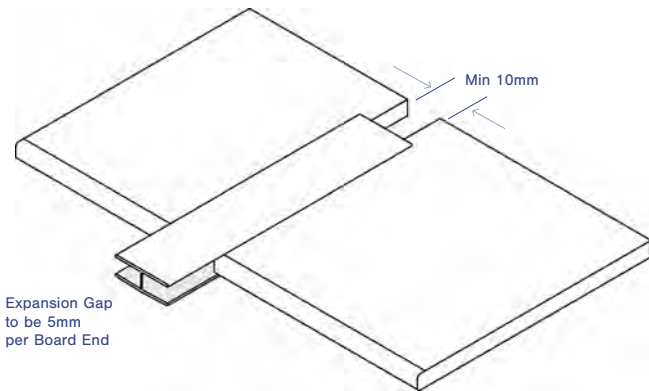

Jointing of Fascia & Bargeboard

All Kestrel fascia board ranges have a series of specifically designed accessories to complement the size and shape of the fascia board.

These include some of the following:

- Extra Large Corner Joints (Typically 600mm for Box ends)
- Standard Corner Joints
- Fascia Joints
- Internal Corner Joints
- End Caps

All joints should be secured using Low Modulus Neutral Cure Silicone.

Gaps to increase to 8mm per board end for foiled products

Fascia Joint Installation

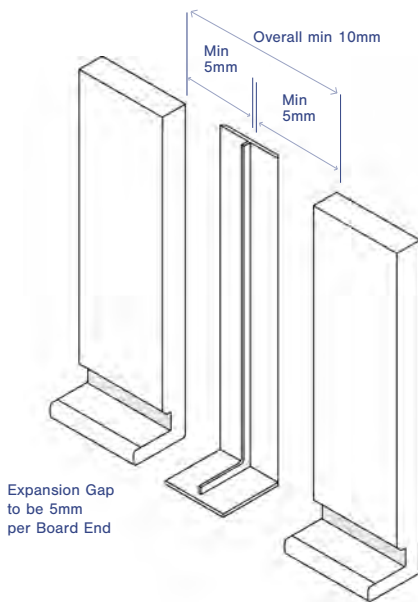

Corner Joint Installation

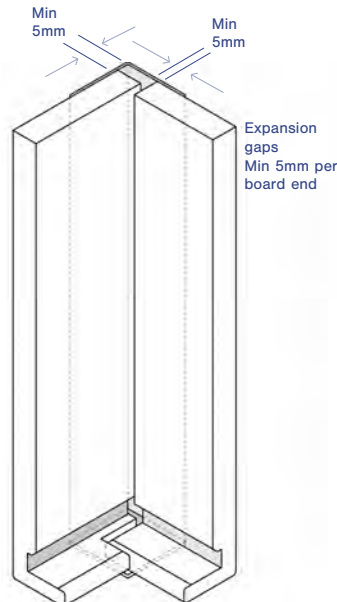

Internal Joint Installation

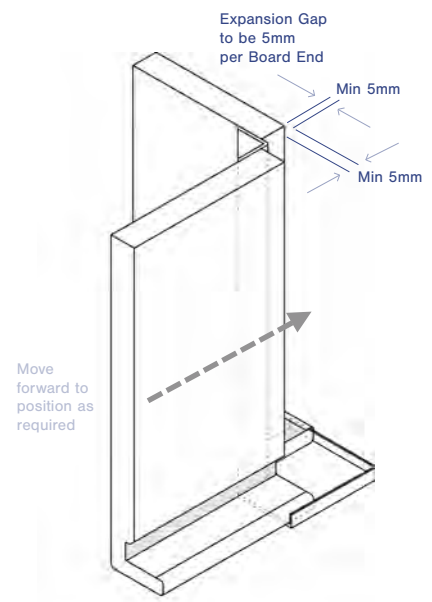

Butt Joint - Plan View

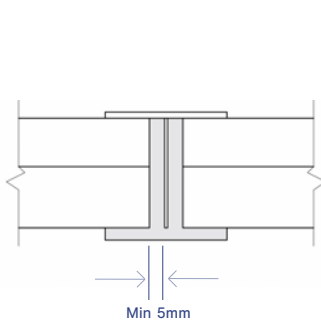

Corner Joint - Plan View

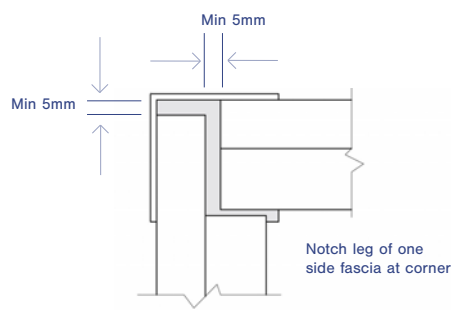

Internal Joint Plan View

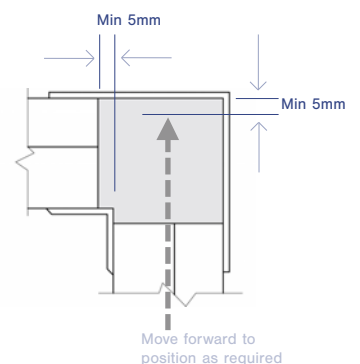

Typical Jointing Details

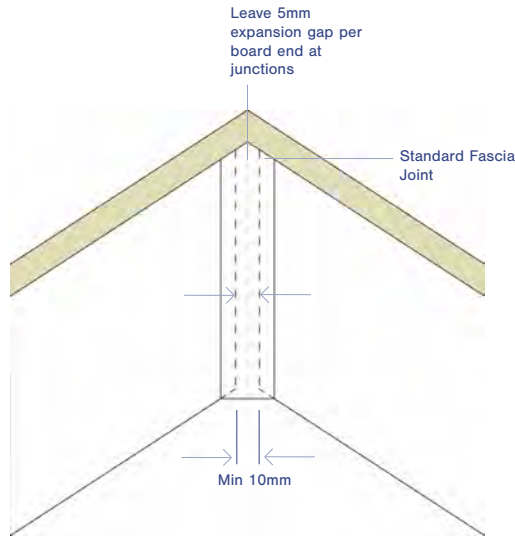

Apex Joint

Apex joints are made utilising a standard fascia joint from the main fascia range cut to suit. e.g. for the K16 range item 649/300.

Alternatively, a decorative finial (K714s) can be used to give a more aesthetically pleasing finish.



Method 1

Method 2

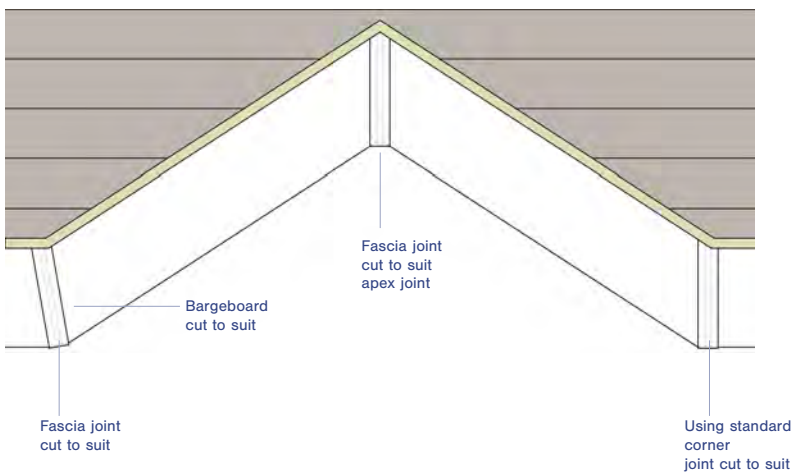

Running Gables / In-Line Pikes

Where fascia meets barge along a running gable, it is important that the same range of fascia and bargeboard is used. This will prevent a step being created.

Four typical methods are shown to the right. The exact method used will be dependent on roof pitch, layout etc.

Method 3

Method 4

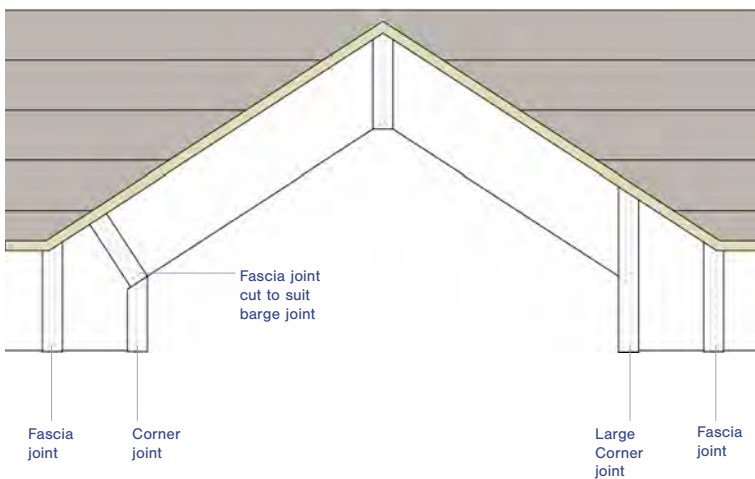

In-Line Pike Junctions

In-line pike junctions can be created using standard joints from the relevant ranges.

Joints and bargeboards will need cutting to suit.

Fascia and bargeboard material will need to be the same type.

In-Line Box End Options

In-line boxends can be created using the same construction methods as shown previously on page 10.

It is important that the same material is used on the barge as is used on the fascia.

This configuration is often used to a side gable where the gable meets a roof projection.

- Fascia and bargeboard material will need to be the same type.

Foiled Fascia Joint Installation Details

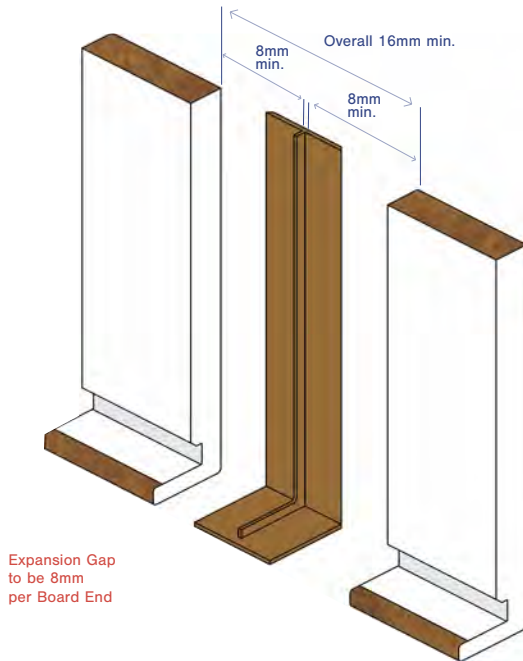

Working with Woodgrain products requires slightly modified procedures and installation processes. Overall, woodgrain products are as easy and convenient to fit and use as most other products in the Kestrel range. However, with a little extra knowledge and care at the preparation stage, you can save yourself potential difficulties later on.

Kestrel's Woodgrain foiled profiles have been extensively tested to ensure long term weatherability and are guaranteed for use both internally and externally for a period of 10 years. However, non-white systems have a different potential for heat absorption, with resultant risk of excessive expansion and contraction. In particular, with a Woodgrain foiled coating, this heat absorption can be significant, with potentially detrimental effects on long term installation. Special consideration needs to be given when installing Woodgrain products to minimise the amount of heat build up and provide for greater amounts of expansion.

The following additional fixing details must be followed when installing Woodgrain products:

Fascias/Bargeboard

1. Increase expansion gap from 5mm for white to 8mm.
2. All installations to take place at ambient temperatures - between 5°C and 25°C.
3. All pre-installed products to be kept away from direct sunlight, preferably indoors, at all times.
4. All joints to be made with Woodgrain corners and butt joints.

Foiled Soffit Joint Installation Details

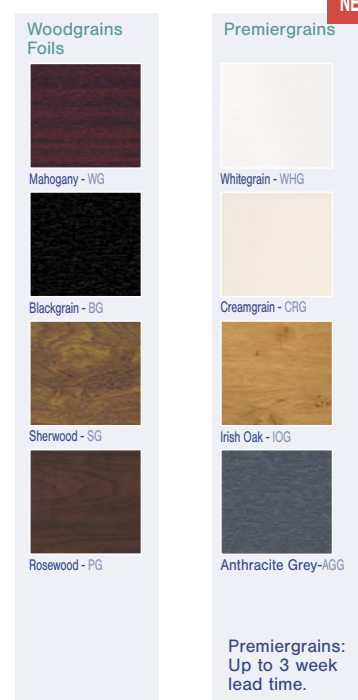
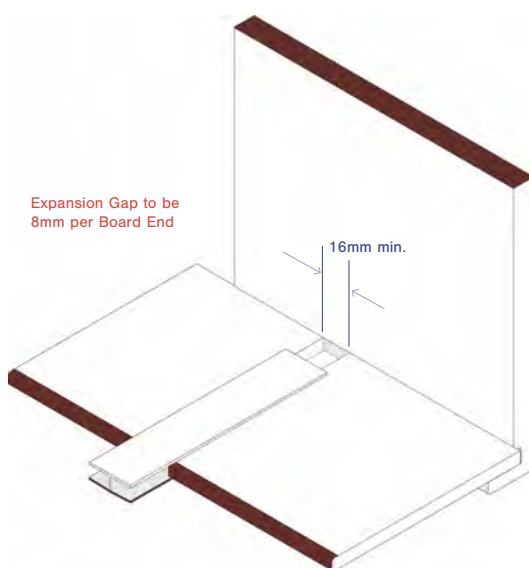

Premiergrains: Up to 3 week lead time.

Fixing Summary - Roofline

Fascia (thickness)	Fixing detail	Fixing type	Product ref.
8 - 10mm Fascia Capping	Detail with 12mm min exterior grade plywood backing board (BS EN 636:2012+A1:2015)	50mm Polytop Nails 50mm Polytop Screws	SS-50N
16mm - 22mm Fascias	Full replacement	65mm Polytop Nails 65mm Polytop Screws 50mm Polytop Screws	SS-65N

Soffit	Fixing detail	Fixing type	Product ref.
9mm Soffit	Soffit bearers recommended	40mm Polypins	SS-40P

Cladding boards used as Soffit	Fixing detail	Fixing type	Product ref.
100mm Open V Joint 150mm Sniplap Cladding	Timber soffit bearers	30mm Cladding Pin	SS-30-CP
Kavex 150mm Open V Joint Kavex 150mm Shiplap Cladding		20mm Cladding Trim Nails for cladding trims	SS-20-CN
Kavex 300mm Shiplap Cladding		Application as cladding system	

Eaves Protection & OFVS systems	Fixing detail	Fixing type	Product ref.
K708 Eaves Protector	600mm centres	30mm Cladding Pins	SS-30-CP
UNIOFV	200mm centres	30mm Cladding Pins	SS-30-CP
K712 & K712/025	200mm centres	50mm stainless steel annular ring shank	SS-50N

NOTE: Unless otherwise stated, all fascia/soffit fixing centres should not exceed 600mm centres

General			
Expansion Gap	White Foils & Colours	5mm per board end	8mm per board end
Fixing Centres	Replacement Fascia - 16mm+	2 per fixing centre, max 600mm centres, 65mm polytop nails (or 65 / 50mm x 4mm shank screws), austenitic stainless steel (grade A4 BS EN ISO 3506-1 : 2009).	
	Overcap fascia - 8mm+	2 per fixing centre, max 600mm centres, 50mm polytop nails (or 40mm x 4mm shank screws), austenitic stainless steel (grade A4 BS EN ISO 3506-1 : 2009).	
	Soffit	Per fixing centre, max 600mm centres, 40mm polytop pins (or 40mm x 4mm shank screws), austenitic stainless steel (grade A4 BS EN ISO 3506-1 : 2009).	
Soffit Boards	Soffit wider than 300mm	Soffits up to 300mm wide require no additional fixing. Soffit boards over 300mm wide should be fixed at maximum 600mm centres along their length and 300mm centres across their width. Fix to adequate timber bearers.	
Load Bearing	Fascia 16mm+	16mm - 22mm boards will support all eaves tiles in common usage in the UK (up 10kg load per 1m length of fascia) provided that the boards are installed within the requirements of the BBA certificate.	
	Fascia <16mm	All fascia less than 16mm require a minimum 12mm exterior grade plywood backing board.	
Joint Fixing		Low modulus neutral cure silicone BS5889 Type A.	
Gutter Fixing	For 16 - 22 mm boards	Fix gutter brackets directly into the board using, for each bracket, at least 2 x 10 gauge x 25mm long (parallel thread form) austenitic s/steel screws, ensuring that the screws penetrate the rear face of the board and that the bracket spacings do not exceed one metre.	
Gutter Fixing	For 9mm boards	For the 9 mm board, gutter brackets are screwed through the fascia board onto rafter feet or other timber support.	



Kestrel's cladding systems are ideal for a wide variety of internal and external applications. The system is offered complete with all trims, fixings and components to ensure a high quality, aesthetically appealing finish. Cladding is an ideal means of covering large areas with a durable, maintenance free solution which will stay looking good for years. It never needs painting and is highly suitable for areas where future access could prove difficult or costly. The design features within the system mean that cladding offers a visually appealing alternative to traditional materials, whether in domestic or commercial applications.

Popular products within the cladding range and the principal elements of installation are detailed here.

Horizontal Cladding

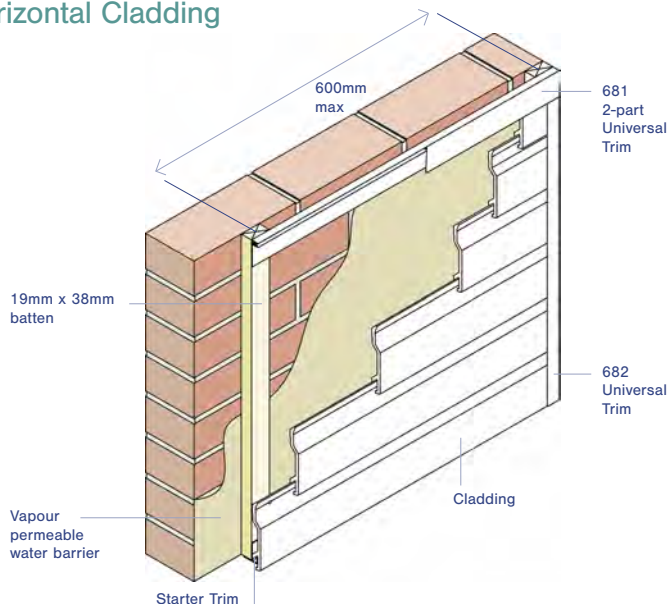

TECHNICAL CONSIDERATIONS - Installation

The Kestrel co-extruded PVC-UE cladding system is suitable for horizontal, vertical and diagonal fixing, as a decorative & protective external facing, over a timber stud or masonry wall.

When used over a sheathed timber stud frame or over a masonry or block substrate, the cladding should be fixed to preservative treated, good quality timber battens (measuring not less than 19mm by 38mm) rigidly fixed to the substrate at 600mm centres or closer.

Installation takes place by fixing trims around the periphery of the area to be clad followed by installation of the cladding planks.

Planks are fixed using stainless steel annular ring shank nails positioned in the groove which runs along the length of the cladding plank. Nailing takes place from the centre of each plank working outwards.

Subsequent planks are fitted over the preceding planks ensuring that the tongue-and-groove joint is firmly closed so that the nail heads are concealed by the overlap. To avoid distortion in service, care should be taken not to install the cladding in extremes of temperature (i.e. below 5°C or above 25°C) and to allow adequate expansion gaps of 5mm per plank end for expansion.

The cladding must be installed to provide a minimum ventilated air space of 19mm between the cladding and the backing wall. This satisfies both NHBC requirement for a minimum 10mm wide ventilation cavity and the Foundation 15 clause for a minimum 19mm cavity to be maintained between claddings and sheathing.

Horizontal battens used to support trims at the base of installations or at window heads, require 10mm diameter drainage holes at 1000mm centres.

Diagonal Fixing

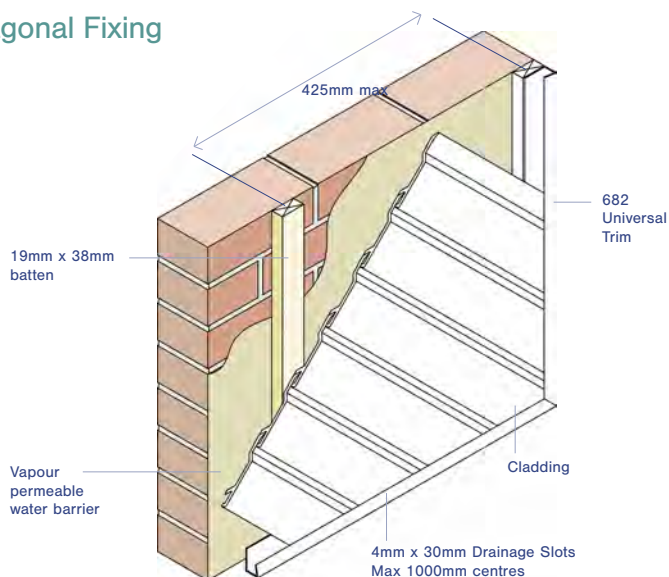

White Cladding Installations

Vertical Cladding

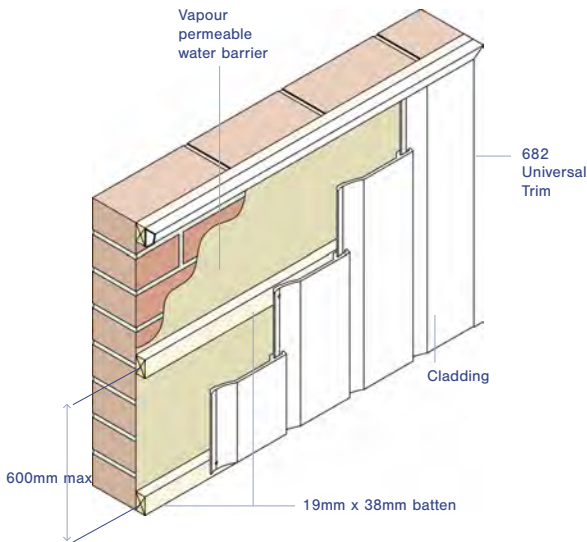

When cladding is used in exposed locations (eg buildings above 10 metres in height, buildings on unprotected sites or in open countryside) it is recommended that batten spacing be reduced, particularly at the corners of the building, in order to increase the resistance to wind suction. The cladding is suitable for use above ground-floor level, and at ground-floor level in private areas where there is some incentive to exercise care.

It is not recommended for use at ground-floor level in public areas where it may be exposed to vandalism and general misuse. PVC-UE cladding installations are not air, water or water vapour tight. When used on timber stud walls the product must be backed by a breather membrane acting as a vapour-permeable water barrier, incorporated behind the cladding under the supporting battens.

This barrier must meet the requirements of BS5250: 2011 and have a vapour resistance less than 0.6 MNsg-1.

Where the product is used as a decorative facing attached to weathertight masonry walls, a water barrier is not necessary as the amount of water that will penetrate the cladding will be small and will not have an adverse effect on the wall.

Behaviour in relation to fire

When tested to BS476: Part 6: 1981 Kestrel white PVC-UE cladding planks achieved a fire propagation index of 15.4 with sub indices and of 7.6, 6.4 and 1.4 respectively.

Kestrel PVC-UE cladding is suitable for use as cladding on the external walls of buildings less than 20m in height (England & Wales) or 15 metres in height (Scotland) provided that the wall is 1 metre or more from the relevant boundary.

The product is suitable for use on the external walls of buildings in Northern Ireland less than 15 metres in height provided the wall is 1 metre or more from the relevant boundary, but excluding use on buildings of purpose group VII (assembly buildings) having more than one storey, at situations up to 7.5m above the finished surface of any adjoining roof or other part of the building to which persons have access.

The product is suitable for use as a cladding on the external walls of buildings 20 metres or more in height (England & Wales) or 15 metres or more in height (Scotland) provided that the wall is 1 metre or more from the relevant boundary and the cladding does not extend higher than 20 metres (England & Wales) or 15 metres (Scotland).

The product is suitable for use on external walls of buildings in Northern Ireland which are 15 metres or more in height provided the wall is 1 metre or more from the relevant boundary and the cladding does not extend higher than 15 metres, but excluding use on buildings of purpose group VII (assembly buildings) having more than one storey, at situations up to 7.5 metres above the finished surface of any adjoining ground, or of any adjoining roof or other part of the building to which persons have access.

When tested in accordance with BS476: Part 7: 1987, the white co-extruded material achieved a Class 1Y rating.

Although the surface spread of flame across the surface of the PVC is limited, the material does tend to char and may fall away when exposed to fire. Due consideration should always be given to any combustible material behind the cladding, which may become exposed in the event of a fire.

CE Marking

CE Marking requires that cladding be tested for its reaction to fire. Kestrel PVC-UE cladding with PVC-U skin achieves a Classification of Reaction to Fire Performance: D-s3, d2/AVM.

- PVC cladding installed over timber framing now carries BRE A+ rating. This allows the specifier to claim the maximum three points available under the CSH for just such an external wall system.

Permissible dynamic wind pressures (Pa)		
Length of fixing nail (mm)	Cladding Profile	
	100mm Open-V	150mm Shiplap
30	2650	1750
25	1750	1150

Trim Locations and Installation

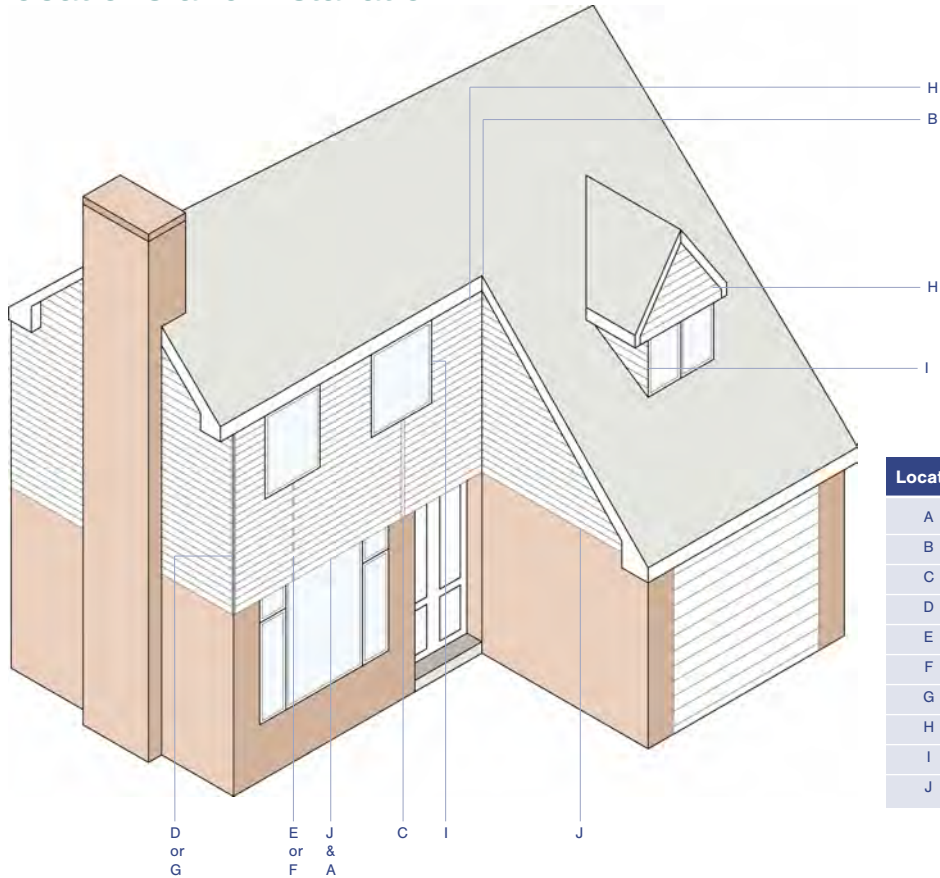

Location	Trim Required
A	5506 Drip Trim
B	675 Internal Corner Trim
C	676 Centre Joint Trim
D	677 External Corner Trim
E	678 150mm Shiplap Cladding Butt Joint
F	679 100mm Open-V Cladding Butt Joint
G	680 2-Part External Corner Trim
H	681 2-Part Top Edge Trim
I	682 Universal Trim
J	683 Starter Trim

Batten Installation Guidelines*

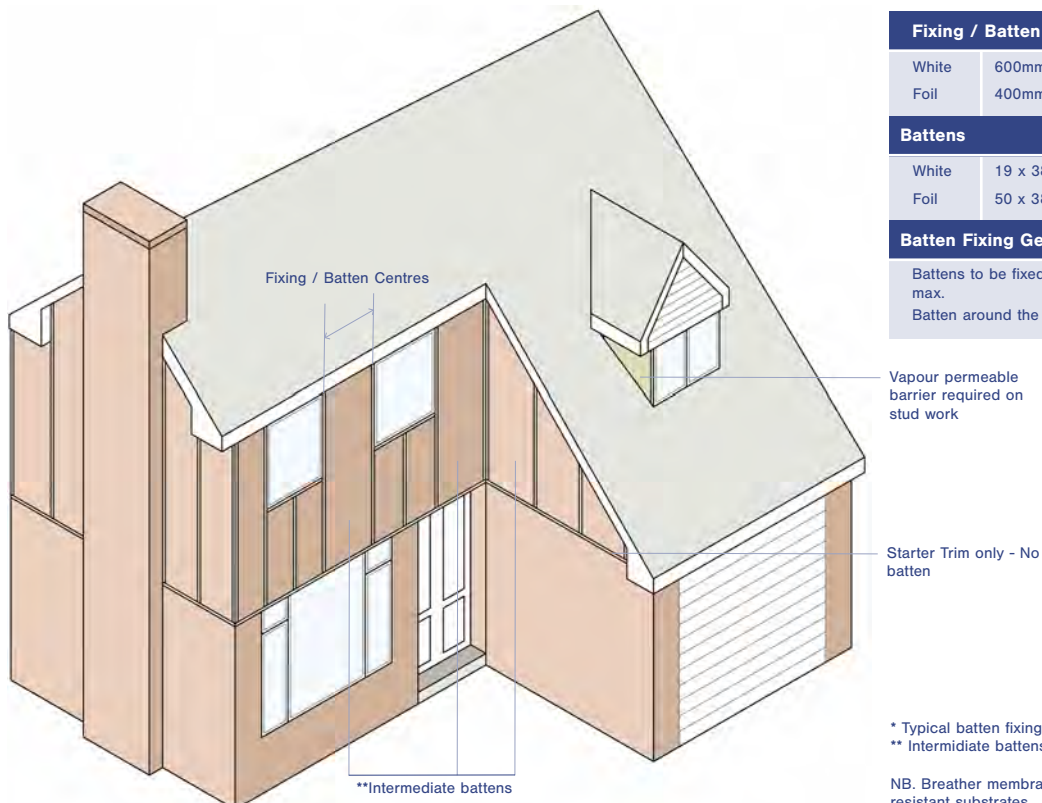

Fixing / Batten Centres	
White	600mm max
Foil	400mm max
Battens	
White	19 x 38mm min. 25mm recommended
Foil	50 x 38mm min.
Batten Fixing General	
Battens to be fixed to substrate at 600mm centres max.	
Batten around the perimeter and all openings.	

* Typical batten fixing for horizontal cladding installation
 ** Intermediate battens removed for clarity
 NB. Breather membrane is only required on non-moisture resistant substrates

White Cladding Installations

Trims Installation

Starter and Drip Trim - Horizontal Installation

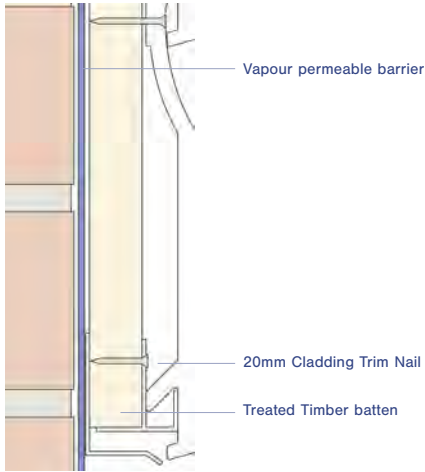

Starter Trim - Vertical Installation

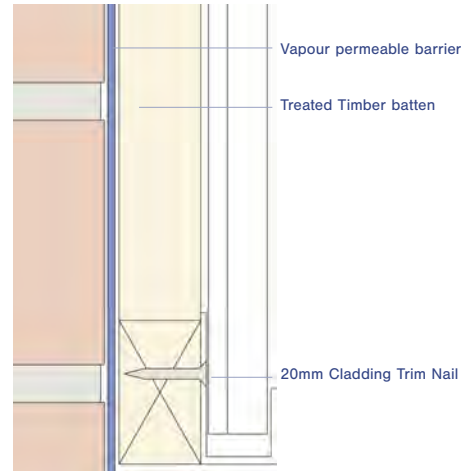

NB. Universal channel must be pre-slotted (4mm x 30mm - Max 1000mm centres) to allow for drainage

Centre Joint Trim Installation

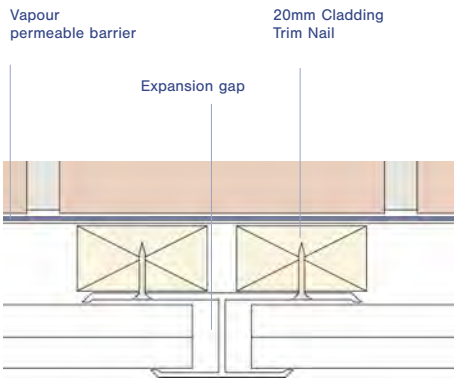

Universal Channel - General Edge Installation

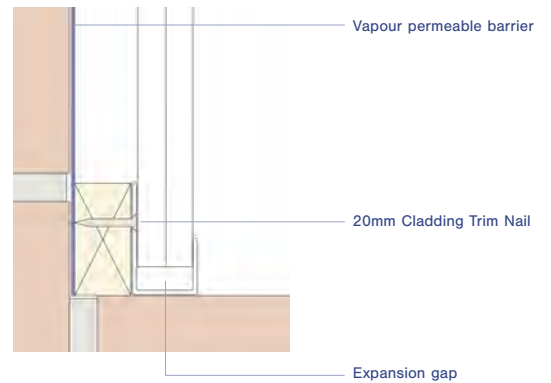

2-Part Top Edge Trim - Horizontal Installation

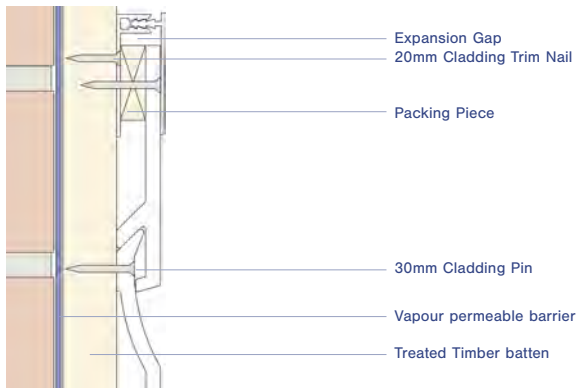

2-Part Top Edge Trim - Vertical Installation to Soffit

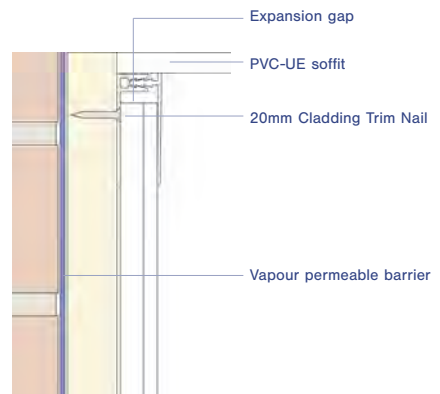

NB. Breather membrane is only required on non-moisture resistant substrates

External Corner - Horizontal Installation

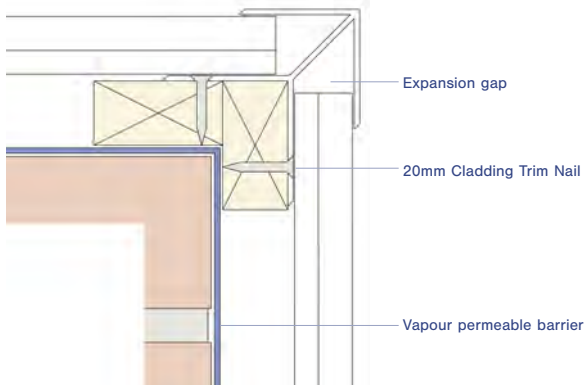

External Corner - Vertical Installation

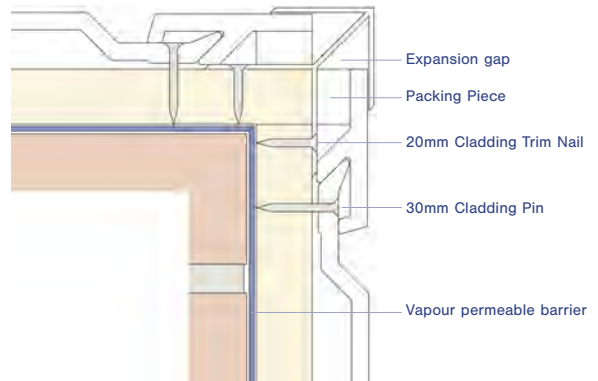

2-Part External Corner - Horizontal Installation

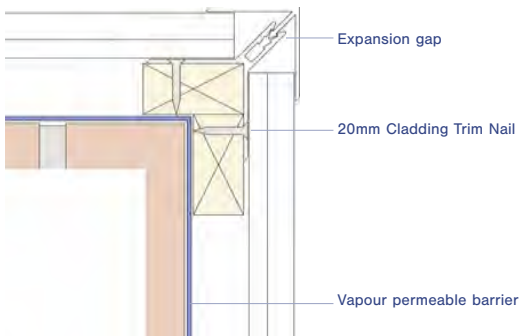

2-Part Corner - Vertical Installation

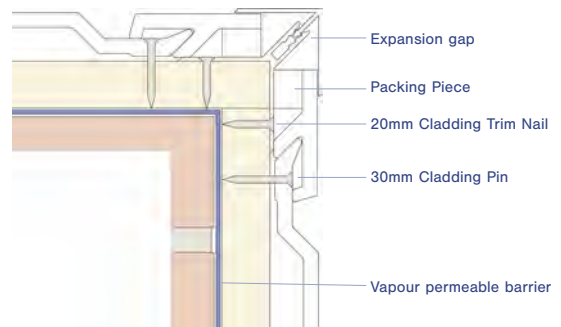

Internal Corner - Horizontal Installation

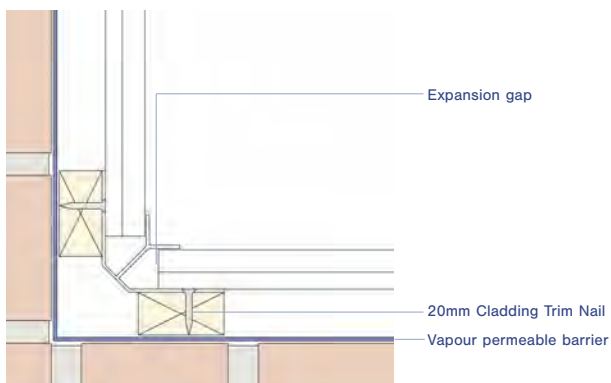

Internal Corner - Vertical Installation

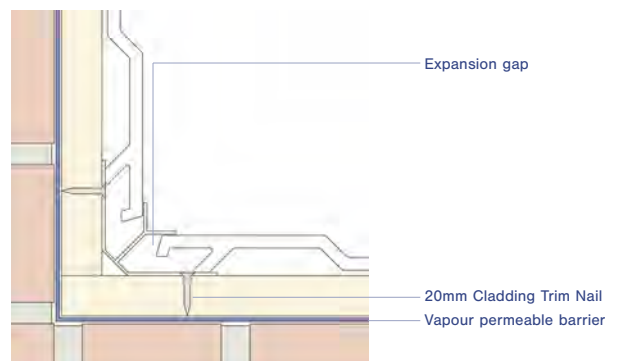

NB. Breather membrane is only required on non moisture resistant substrates

White Cladding Installations

Variable External Angle - Horizontal Installation

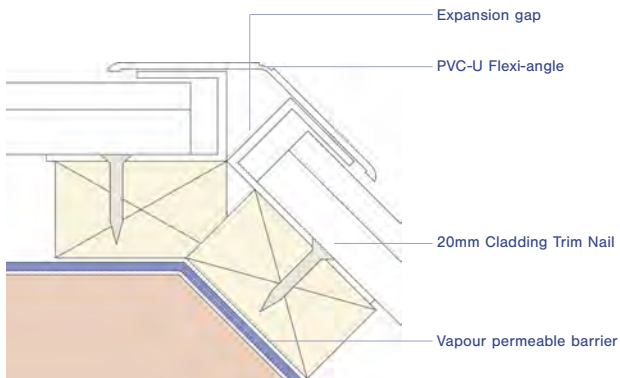

2-Part Top Edge Trim Installation to Window Cill

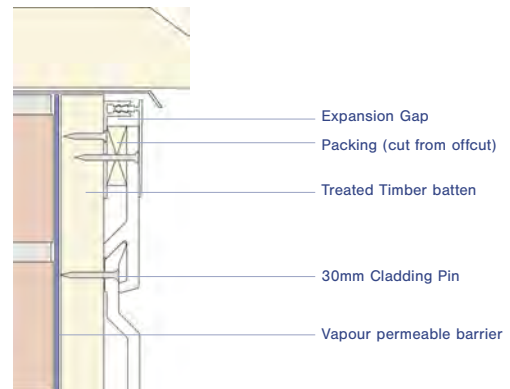

Cladding System



NB. Breather membrane is only required on non-moisture resistant substrates

Installation Detail - Horizontal Cladding

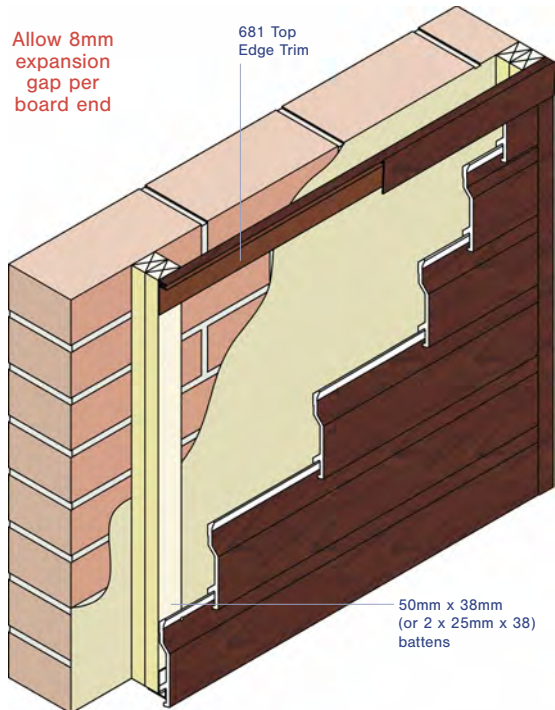

Working with Woodgrain cladding requires some modified procedures and installation processes. The following fixing details must be followed when installing Woodgrain cladding products:

1. Allow a minimum of 50mm air space behind the back of all cladding installations.
2. Using the Universal Channel or Starter Trim with Batten Cover at both the top and base of each cladding face, allow a 10mm air gap at the top and bottom of each cladding unit in order to generate air flow behind the installation. When installing cladding vertically the use of counter battens is required.
3. Install 5m (max.) cut lengths and fix firmly at the centre of each cut length with Cladding pins as recommended for white profile. All subsequent fixings, at maximum 400mm centres from the central fixing point, into fixing slots. These fixing slots should be 10mm long, with a width of 0.5mm wider than the cladding nail shank. Fix with a large headed nail as recommended for white profile ie 30mm stainless steel annular ringshank nails (SS-30-CP)
4. Jointing of boards to be made with 676 cover joint trim, allowing an 8mm expansion gap at every board end.
5. Installations to take place at ambient air temperature - between 5°C and 25°C.
6. All pre-installed products to be kept stored away from direct sunlight, preferably indoors, at all times.
7. All end finishing cover strips etc. should allow an 8mm expansion gap between the end of the cladding profile and the cover stop.

These precautions will allow airflow behind the cladding which helps to reduce excessive heat build-up.

They also allow a free expansion and contraction of the profile along the profile length from a central fixed point. Expansion gaps at joints and finishing strips also allow for freedom of expansion.

CE Marking requires that cladding be tested for its reaction to fire. Kestrels PVC-UE cladding with PVC-U skin & Laminate Foil achieves a Classification of Reaction to Fire Performance: E.

Installation Detail Vertical Cladding (counter batten)

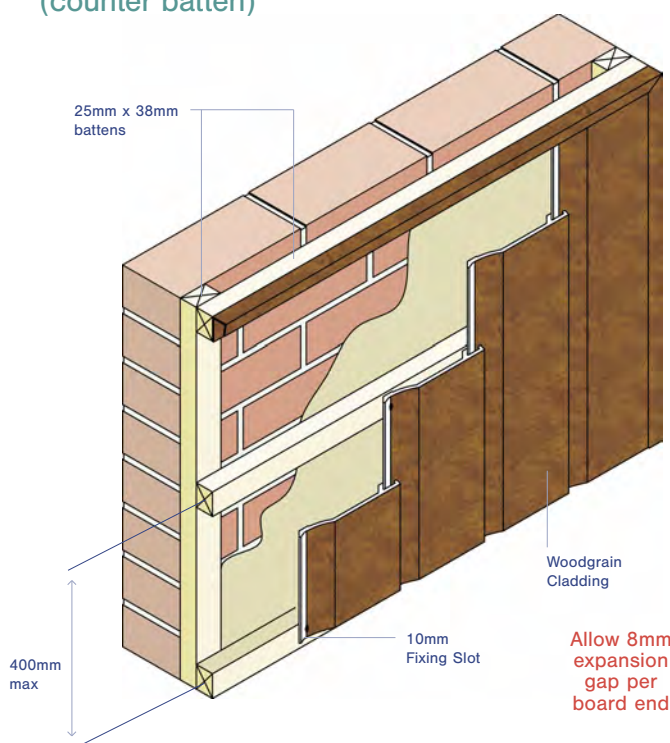

NB. Breather membrane is only required on non-moisture resistant substrates

Fixing Summary - White and Foiled Cladding

Fixing Details

Batten fixings	into masonry: into steel: into timber:	Hammer screws Self-tapping screws Plated woodscrews.
Cladding fixings	30mm stainless steel Cladding Pins.	SS-30-CP
Trim fixings	20mm stainless steel Nails.	SS-20-CN
Breather membrane		To be positioned behind the batten system against the substrate.

If Fixing Insulation Behind Important Points Which Must Always Be Observed:

- Ensure cladding batten system is fully supported cladding system
- Fix at recommended fixing centres
- Always detail a suitable secondary waterproofing material (EXAMPLE: Vapour permeable breather membrane to maintain a watertight structure
- The membrane should be positioned on the external face of the insulation between the insulation and the cladding
- Maintain the correct statutory airspace behind the cladding system

Area Calculations

Cladding:	Product Code:	5m Lengths Required Per Square Metre:	Coverage Per Linear Metre:
Open V Joint Cladding	671/100	2.0	0.1m ²
Shiplap Cladding (150mm profile)	670/150	1.4	0.15m ²

Fixing Centres

Cladding:	Product Code:	Batten / Fixing Centre:	Product Code:
White	671/100 & 670/150	1 per fixing centre, max 600mm centres	SS-30-CP
Foils	671/100 & 670/150	1 per fixing centre, max 400mm centres	SS-30-CP

All fixings to be A4 marine grade, austenitic stainless steel (grade A4 BS EN ISO 3506-1 : 2009).

General

Battens	White plain cladding	Minimum 19mm x 38mm (25mm x 38mm recommended)
	Foiled cladding	Minimum 50mm x 38mm (or 2 x 25mm x 38mm)
Ventilation	White	Allow a minimum of 19mm ventilated air space behind the back of all cladding installations. This satisfies the NHBC requirement for a minimum 10mm wide ventilation cavity to be maintained between claddings and sheathing.
	Foils	Allow a minimum of 50mm ventilated air space behind the back of all cladding installations
Expansion Gap	White	5mm per board end
	Foils	8mm per board end
Joint Fixing		Low modulus neutral cure silicone BS5889 Type A
Installation Temperature		To be installed between 5°C & 25°C temperatures

Fire Rating

	Finish	Thickness (mm)	Class
BS476 Part 7	White	6mm	1Y
EUROCLASS BS EN ISO 11925-2	White	6mm	D-s3, d2
EUROCLASS BS EN ISO 11925-2	Laminated Foil	6mm	E



Batten Installation - Kavex Only

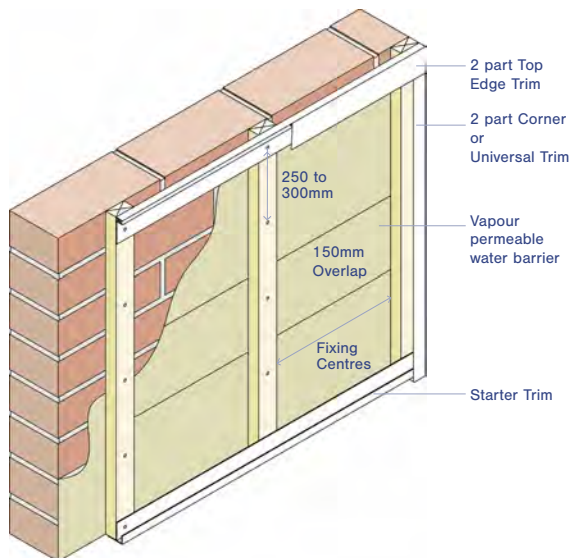

White - W

Cream - 9001

Sand - 1015



Light Blue - X002

Light Grey - 7035

For Kavex textured cladding, standard fitting instructions can be followed. However, due to the differing sizes and colours available in the Kavex range, slightly modified batten fixings are required. Where required, ensure breather membrane is positioned beneath the batten system against the substrate.

Battens

- Set out and fix 25mm x 38mm tannalised battens vertically.
- Ensure battens are parallel straight and level.
- Fix battens to the substrate at 300mm maximum centres. (600mm for 150mm single planks)
- Fix a tannalised batten along the top of the installation.
- No batten is needed along the base of the cladding system because it relies on this opening to dispel excess moisture and to be used as a point of ventilation.

Battens

- Fix the starter trim to the battens at the base of the installation with 20mm A4 stainless steel nails.
- The starter trim is designed to locate the first cladding plank.
- Measure and cut to size the vertical universal trim or corner trim notch out at the rear of the trim.
- Ensure that the trim is straight and plumb and fix onto batten with A4 20mm stainless steel fixings at 250mm-300mm intervals.
- Trims are designed to take up expansion - ensure a 5mm gap between board edges/ends and trim stops for White cladding and 8mm for RAL9001, RAL1015, RAL7035 and X002.
- Note there are two part versions of the vertical trims for use with horizontal and vertical cladding applications.
- Measure, cut and fix the top edge trim male extrusion to the top of the installation between the two vertical trims. Ensure you notch out the rear of the vertical trim to accommodate the male top edge extrusion.
- The installation is now ready to accept the first cladding plank.
- Measure first cladding plank ensuring that there is the correct gap left on either end of the plank for expansion.
- Before fixing plank locate groove section of the cladding plank into the location lip of the starter trim.
- Ensure plank is straight and level using a spirit level.
- Fix plank to each batten centre using A4 30mm stainless steel nails or 8 -gauge x 30mm stainless steel countersunk headed screws.
- Ensure fixings pass through nail/screw guideline groove as the boards are a concealed fix.
- Locate second board, ensure groove of second board covers the tongue of the first board fully as not to show nail/screw heads.
- Follow this procedure until you reach the top of the installation, ensuring that each board is located properly.
- Ensure the installation is checked for level every three boards.
- Measure width of last board.
- Cut down last board and use the off cut tongue of the board as packing material. This will be spot glued (Cynocrylate adhesive) to the back of the last cladding plank and then nailed through into the top batten once located.
- Locate top cladding plank & fix through plank into top batten.
- Cut and snap on female part of trims to the vertical male extrusion ensuring that the trim finishes at the top of the installation.
- Measure cut and snap on the top edge trim ensuring that the trim is fixed between the two vertical trims.

NB. Breather membrane is only required on non-moisture resistant substrates

Kavex Textured Cladding Installations

Wall Starter Trim Installation - Kavex Only

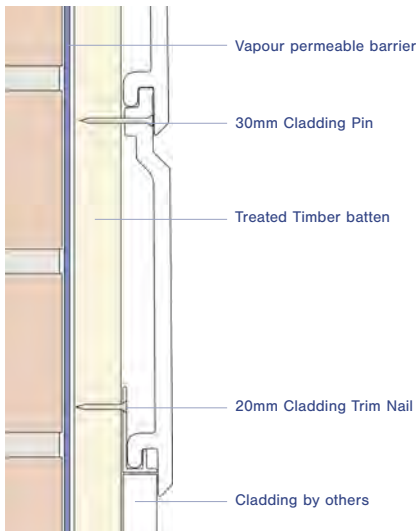

2pt Centre Joint Trim Installation - Kavex Only

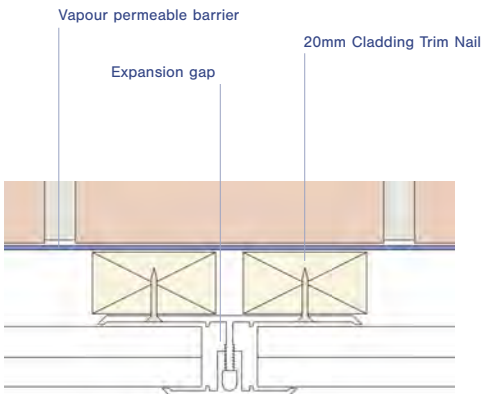

2pt Universal Trim Installation - Kavex Only

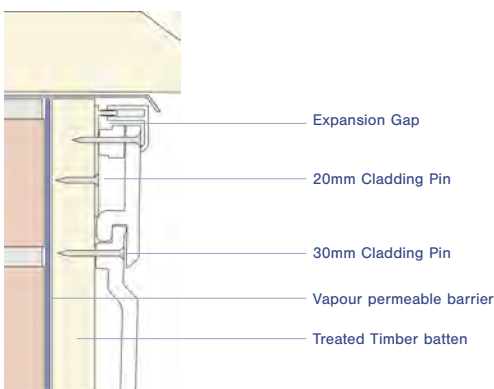

Vertical cladding

The same preliminary work as a horizontal cladding application will need to be completed before cladding can commence.

Preliminary work

- Secondary waterproofing membrane.
- Batten orientation and spacing.
- Battens to be installed horizontally for a vertical cladding application.
- A top batten and bottom batten are required.

Method

- Fix battens at the correct 300mm centres. (600mm for single planks)
- Pack out battens where necessary to ensure they sit straight & level.
- Measure, cut and fix drip trim to base of installation to act as a first location for the cladding plank.
- It is important to use two part trims on a vertical cladding application.
- Measure, cut and fix universal trim male extrusion to vertical edges of installation (flat section panel application).
- Measure, cut and fix universal trim to top of cladding installation.
- Measure and cut first cladding plank ensuring that there is 5 / 8mm removed from each end of the plank for expansion.
- Fix first plank with A4 30mm stainless steel nails or A4 - 8 gauge x 30mm A4 stainless steel screws ensuring that the plank sits neatly inside the vertical end trim to start the cladding line. The female part of the trim when snapped on will locate the groove intersection of the cladding board. It is advisable to nail through the base of the board to hold it in position, then snap on the trim female part to hide the fixings.
- Ensure the cladding board is plumb using a spirit level.
- Nail/screw the first board through the nail/screw groove guide lines on the board at every batten centre.
- The boards are a concealed fix so ensure the nail/screw heads are flush with board and through the nail/screw groove guide.
- Work from left to right of the installation and measure cut and fix each board in turn.
- The boards should be checked for plumb every three boards.
- Also check that each board is located properly.
- Measure and cut the last board allowing for the correct expansion gap & engage it into the trim. The tongue of the board will be used as a packing piece to ensure the board is fixed securely into the trim.
- Cut and spot glue the tongue of the board (Cynoacrylate adhesive) to the rear of this last board.
- Fix the board with A4 grade 30mm stainless steel nails or A4 - 8 gauge x 30mm stainless steel screws through the face beneath where the finishing trim is being located.
- Measure, cut and snap-on vertical trims.
- Measure, cut and snap-on the horizontal top edge trim to finish installation.

Diagonal cladding

The same preliminary work & installation techniques as a horizontal cladding installation will need to be observed with a few differences.

Method

- Reduce batten centres to 210mm.(450mm for 150mm single planks).
- Measure, cut and fix drip trim or universal trim to base of installation to act as a first location for the cladding plank.
- Use 2-part Centre Joint Trim fixed on twin battens if cladding is to be mirrored.
- Use first plank as a template to mark out second plank and so on.



Fixing Summary - Kavex Textured Cladding

Fixing Details

Batten fixings	into masonry: into steel: into timber:	Hammer screws Self-tapping screws Plated woodscrews.
Cladding fixings	30mm stainless steel Cladding Pins.	SS-30-CP
Trim fixings	20mm stainless steel Nails.	SS-20-CN
Breather membrane		To be positioned behind the batten system against the substrate.

If Fixing Insulation Behind Important Points Which Must Always Be Observed:

- Ensure cladding batten system is fully supported cladding system
- Fix at recommended fixing centres
- Always detail a suitable secondary waterproofing material (EXAMPLE: Vapour permeable breather membrane to maintain a watertight structure
- The membrane should be positioned on the external face of the insulation between the insulation and the cladding
- Maintain the correct statutory airspace behind the cladding system

Area Calculations

Cladding:	Product Code:	5m Lengths Required Per Square Metre:	Coverage Per Linear Metre:
Textured Open V Joint Cladding	SVE/150	1.4	0.15m ²
Textured Shiplap Cladding - 150mm	DCE/150	1.4	0.15m ²
Textured Shiplap Cladding - 300mm	DCE/300	0.7	0.3m ²
Textured Feather Edge Cladding	DFE/270	0.75	0.27m ²

Fixing Centres

Cladding:	Product Code:	Batten / Fixing Centre:	Product Code:
Kavex Textured Single Plank	SVE/150 & DCE/150	1 per fixing centre, max 600mm centres	SS-30-CP
Kavex Textured Double Plank	DFE/270 & DCE/300	1 per fixing centre, max 300mm centres	SS-30-CP

All fixings to be A4 marine grade, austenitic stainless steel (grade A4 BS EN ISO 3506-1 : 2009).

General

Battens	Kavex	Minimum 25mm x 38mm
Ventilation	Kavex	Allow a minimum of 25mm ventilated air space behind the back of all cladding installations
Expansion Gap	White Foils & Colours	5mm per board end 8mm per board end
Joint Fixing		Low modulus neutral cure silicone BS5889 Type A
Installation Temperature		To be installed between 5°C & 25°C temperatures

Fire Rating

	Finish	Thickness (mm)	Class
BS476 Part 7	White / Coloured	7mm	2Y
EUROCLASS BS EN 13823 & BS EN ISO 11925-2	White / Coloured	7mm	D-s3, d2



Kestrel makes a wide range of products for interior applications and to support the window fitting industry. This range includes window boards, reveal liners, trims, architraves and skirtings.

PVC-UE products used in interior and window application offer several key advantages over traditional building materials. PVC-UE products:

- are durable and long lasting
- are lightweight, quick and easy to install
- do not need painting or any other form of treatment
- can be worked with conventional tools by traditional trades

Installation of reveal liner, silicone fix with quadrant

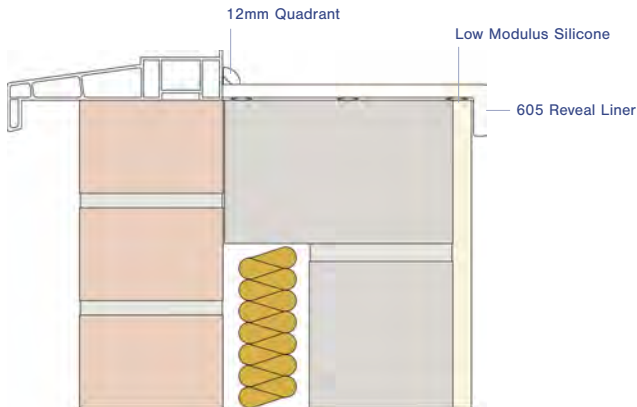

Installation of windowboard, silicone fix with window board channel

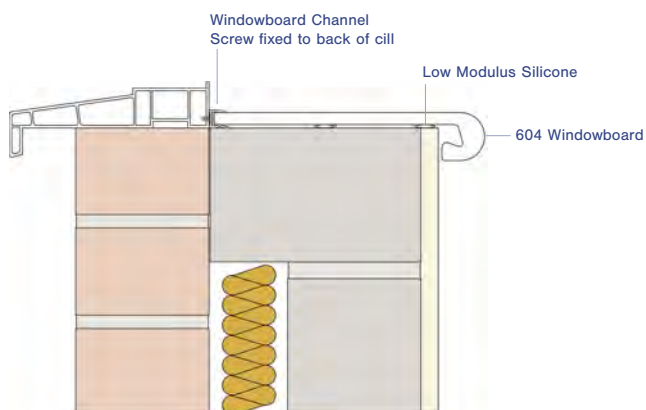

GENERAL

Installation Conditions

Kestrel internal trim profiles should only be fixed within the recommended installation temperatures of 5°C and 25°C. Boards should not be sprung between fixed points. A gap of 1mm/m at each board end should be allowed for thermal expansion on white boards and 1.3mm/m on Woodgrain foiled boards. It is recommended that products are only used in circumstances where the maximum internal temperature will not exceed 30°C.

Prior to installation it should be ensured that the substrate is sound, level and free from dust or moisture. The relevant profile should be cut to size and mitred if required.

Cutting The Material

Workability of PVC-UE and PVC-U is similar to that of timber. All Kestrel products can be sawn, drilled and planed using traditional joinery tools. Hand saws should have a fine tooth blade. Power tools should be run at speeds similar to, or in excess of, those used for timber. When using power tools, a coarse particle dust mask, eye protection and light industrial gloves should be worn.

Repairs and Remedial Work

In the event of a profile becoming damaged in service, it is recommended that the damaged profile be removed and replaced to ensure full product performance.

In-Service Maintenance

In order to maintain the as-new finish it may be necessary to wash the profiles occasionally to remove surface dirt. This can be done easily with soap and water. When wiping over, use a soft cloth and never use solvent-based or abrasive cleaners.

Storage

Products should be stored on a clean level surface in stacks not exceeding 1m in height and restrained from collapse. If stored externally, the product must be kept under cover.

Woodgrain

It is not recommended to use Cyanoacrylate adhesive (Super Glue) on foiled products.

Selection of Boards

Kestrel's 9mm thick boards are suitable for the majority of applications. However in certain applications, it may be necessary to consider the use of thicker boards, e.g. K16 & K22, with their superior strength and rigidity. Consideration should be given in the following circumstances:

- New Build type applications where a board is required to bridge a cavity.
- Fixing over irregular or uneven substrates.
- Situations where boards may be subject to above average loading.

Windowboards and Trims

INSTALLATION

Reveal Liner

Window board channel should be fixed to the inner surface of the window frame using fixing screws suitable for the window frame material, in lengths corresponding to the reveals to be cloaked. Reveal liner may also be installed without the use of window board channel by butting up directly to the inner window frame.

Packing pieces should be introduced under the board to level it out if required. Continuous 6mm wide beads of Low Modulus Silicone should be applied to the front, middle and rear of the underside of the board.

The board should be bedded into the substrate and, where used, located into the window board channel. The product may require to be held in place to allow the silicone to skin.

The installation should be finished by filling all gaps with acrylic Sealant. Internal reveal corners can be trimmed using a slimline internal corner joint, applied after installation of the boards and secured using Low Modulus Silicone. Exposed board ends are trimmed using end caps secured with Low Modulus Silicone or Cyanoacrylate adhesive.

Installation of windowboard to timber frame with quadrant

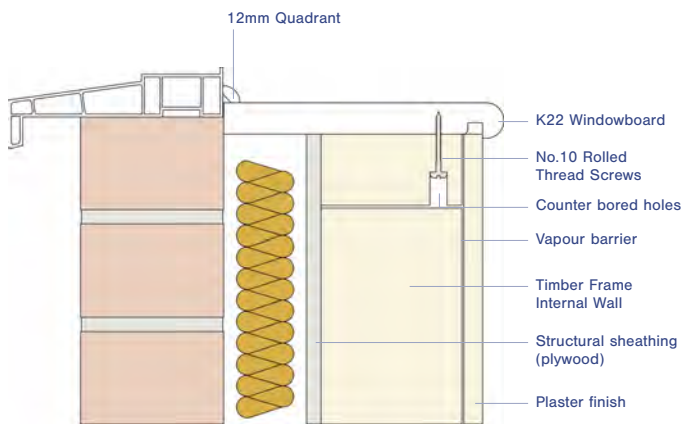

Installation of windowboard, silicone fix to new / existing window board

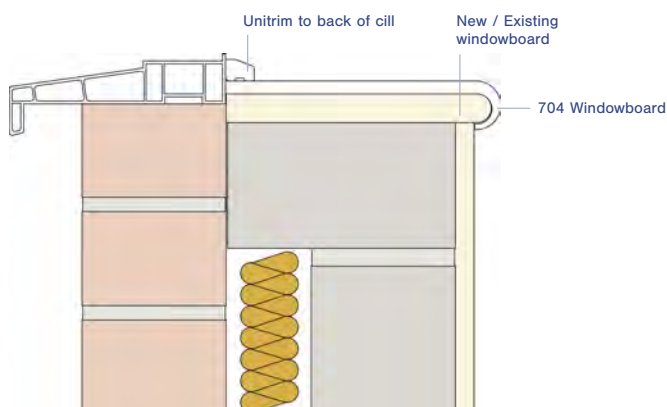

Window Boards

Internal window boards may be fixed over existing window board or directly to the internal building construction, using either of the methods detailed. On New Build or when fixing over uneven substrates, thicker boards such as K22 and K16 are recommended.

Window board channel should, if required, be fixed to the inner surface of the window frame/cill, using fixing screws suitable for the window frame material. Where required, packing pieces should be placed under the window board channel for support. Window board may also be installed without the use of window board channel by butting up directly to the window frame/cill. Packing pieces should be introduced under the board to level it out if required. Window board channel is the recommended option due to its positive location and the lack of a need for further trimming.

Continuous 6mm wide beads of Low Modulus Silicone should be applied to the front, middle and rear of the underside of the board. The board should be bedded onto the substrate and where used, located into the window board channel. The board may require to be held in position to allow the silicone to skin. The installation should be finished by filling all gaps with Acrylic sealant. Visible window board ends are finished using end caps which may be applied with Low Modulus Silicone or Cyanoacrylate adhesive. Note: It is recommended that the overhang on all window board installations be kept to a minimum.

Skirting and Architraves

Low Modulus Silicone should be applied in a continuous 6mm bead to the upper part of the back of the profile, and peaks of the same silicone applied at maximum 250mm centres to the lower part of the profile. The profile is then bedded into position. The profile may require holding in position to allow the silicone to skin. The installation should then be finished by filling gaps with acrylic sealant.



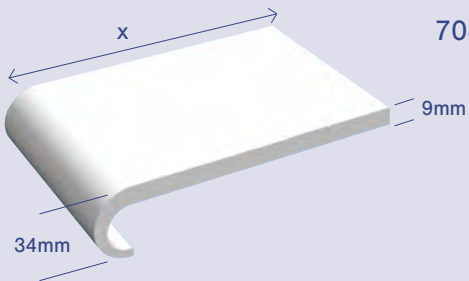
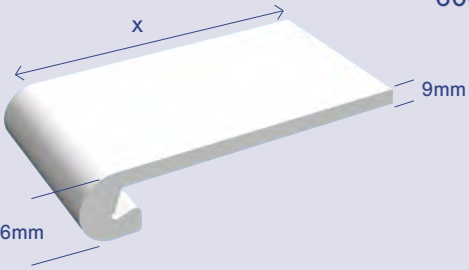
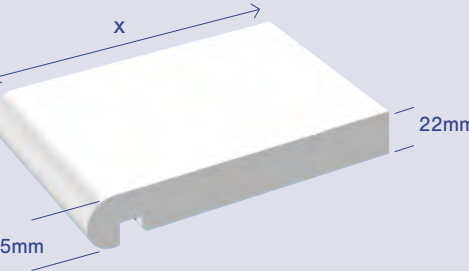
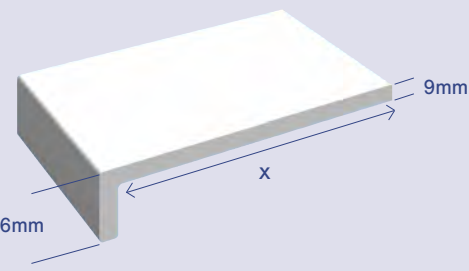

Finishing Trims

To provide a finished appearance to installations, PVC-UE trims should be used. Trims are installed using Low Modulus Silicone. Following application of silicone to the rear of the trims, they are bedded into position and when required held in position to allow the silicone to skin.

		Code	Dimension X
 <p>704</p>	704	704/150	150mm
		704/175	175mm
		704/200	200mm
		704/225	225mm
 <p>604</p>	604	604/125	155mm
		604/175	205mm
		604/200	230mm
		604/225	255mm
 <p>K22</p>	K22	K22/150	150mm
		K22/175	175mm
		K22/200	200mm
		K22/225	225mm
 <p>605</p>	605	605/100	100mm
		605/125	125mm
		605/150	150mm
		605/175	175mm
		605/200	200mm
		605/225	225mm
		605/250	250mm
		605/300	300mm
		605/405	405mm
		605/450	450mm
		605/600	605mm

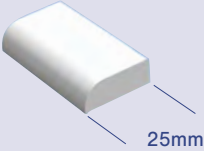
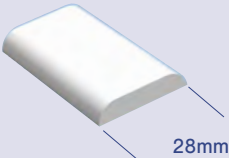
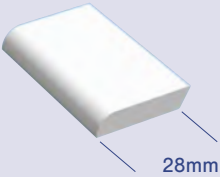
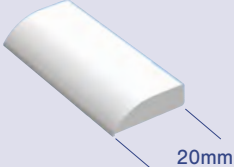
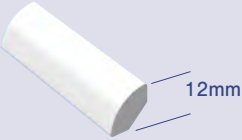
*For full list of trims please see current price list.

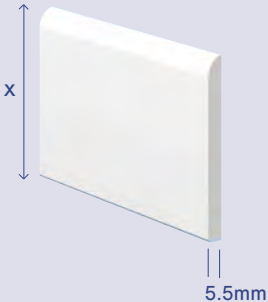
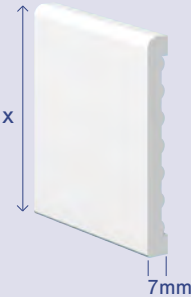
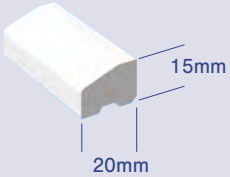
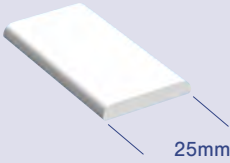
Trim Range

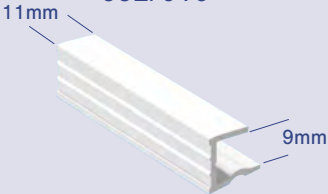
		Code	Dimension X
607/025	607/028	607* 607/025	25mm x 9mm Edge Fillet
		607* 607/028	28mm x 6mm D-section
686	609/020	686 686	28mm x 6mm Cloaking Fillet
		609* 609/020	20mm x 6mm Edge Fillet
608/012	608/019	608* 608/012	12mm quadrant
		608/019	18mm quadrant
712	723	712 712/045	45mm Flat Back Architrave
		712/065	65mm Flat Back Architrave
		712/095	95mm Flat Back Architrave
610	685	723 723/040	40mm Castellated Architrave
		723/060	60mm Castellated Architrave
		723/080	80mm Castellated Architrave
687	652/010	723/090	90mm Castellated Architrave
		723/100	100mm Castellated Architrave
		610* 610	20mm x 15mm Unitrim
		685 685	25mm x 4mm D Section
		687 687	15mm x 13mm Rectangle
		652* 652/010	9mm Window Board Channel

*For full list of trims please see current price list.



Kestrel's technical team is always willing to offer advice and practical assistance with planned installations. Our team can guide you as to the most appropriate products, expected product life, ease of installation and more. We are also able to provide estimates in terms of bills of quantities and to supply full health and safety information about each product in the range. Where you have a particularly large or complex installation, please call on us at the planning stage. One of our area sales managers can then visit you to advise on the best options for your application.

In the meantime, here are the answers to the ten most frequently asked questions about Kestrel's products and PVC-UE applications in general

1. With what do you recommend fixing cover and corner joints to fascia board?

A: Low Modulus Neutral Cure Silicone.

2. What is the minimum coverage of waveline products - V-WAVE & V-CREST?

A: A minimum of 150mm.

3. Has hollow soffit got a Class 1 Fire Rating?

A: No, whilst PVC-UE products in the Kestrel range have, hollow soffit has not.

4. Are Woodgrain products guaranteed for external use?

A: Yes for 10 years and white products are guaranteed for 20 years.

5. Does Kestrel supply vented soffit with an insect mesh?

A: Kestrel does not recommend the use of mesh. The soffit vent slots comply with BS5250 with regard to minimum slot size. Further reduction in slot size via the use of mesh may result in the vent area becoming blocked by airbourne dust and debris.

6. What expansion gaps are required when installing Kestrel products?

A: For white products there should be an expansion gap of 5mm per board end (eg. 2 boards butting up to each other in the same plane = 10mm gap). When installing Woodgrain product this gap is increased from 5mm to 8mm per board end.

7. Are PVC cladding products suitable for use in swimming pool buildings?

A: Yes, contact with swimming pool water is not detrimental to PVC.

8. Is it better to install the thickest board available?

A: For a replacement installation, a 16mm fascia board will perform equally as well as thicker products, requiring no additional support and taking both gutter and tile loading. If the 16mm board chosen is K16, it can be teamed with 9mm 605 bargeboard to give a cost effective performance installation.

9. What is the coverage of Kestrel Shiplap and Open-V Cladding boards?

**A: 670/150 Shiplap = 150mm
671/100 Open-V = 100mm**

10. What is the length of the leg on Kestrel 'L Boards'?

A: Both K16 and 605 have the same length of leg, which is 36mm.

Kestrel is constantly updating and developing its product range and reserves the right to amend or change the information and advice given here at its absolute discretion. For the latest product information, please contact Kestrel on the telephone number shown on the back cover.

A) TECHNICAL DATA

Many of the applications for PVC foam profile are for wood-replacement products due to its ease of installation and the advantages of a low maintenance product. The principal products in the Kestrel range are manufactured by co-extruding a highly weather-able PVC-U compound (skin) onto a PVC-UE compound (core), cooling and forming into the desired section.

In order to obtain a high quality product with the required stiffness, strength and impact performance, it is important to control foam density, skin thickness, surface finish and cell size distribution. Formulations contain a mixture of processing aid, thermal stabilisers, lubricants, pigment and filler in addition to the blowing agents required for foaming. The cellular structure is generated by the decomposition of chemical blowing agents, e.g. sodium bicarbonate (baking powder). The latest calcium organic stabiliser technology is utilised to provide optimal performance. Other products in the Kestrel range (rigid profile and joints) are manufactured using conventional extrusion or injection moulding techniques.

OPTICAL PERFORMANCE

Colour

The surface colour of the profile shall be uniform and be within the optical limits as specified by Kestrel's test procedure and specification for each particular colour.

Appearance and Finish

The profile shall be free from foreign bodies, cracks or sink marks when viewed by normal corrected vision at 90° to the surface and at a distance of 1 metre in normal diffused north light.

Subject to normal wear and tear, Kestrel's PVC-UE and PVC-U profiles will retain their optical and mechanical properties for a period of at least 20 years for white and 10 years for Woodgrain foiled, with only minor changes in surface appearance. Additional care should be taken with foiled and colour finishes to ensure that correct installation procedures are followed.

CLEANING & MAINTENANCE

Kestrel products are low maintenance and with the required care and attention will stay looking good for years to come. However, there are some external factors which may adversely affect the appearance of any PVC, especially after extended weathering:

- Solvent based cleaners
- Abrasive cleaners
- Environmental contamination e.g. dirt / pollen

In order to maintain the appearance, it will be necessary to wash the installation with warm soap and water to remove surface dirt. The frequency of this will depend upon the local environmental conditions. This cleaning should be carried out with copious amounts of soapy water to avoid any chance of scratching of the surface.

When wiping over ALWAYS use a soft cloth or sponge.

NEVER use solvent-based cleaners.

NEVER use abrasive cleaners.

Repairs and Remedial Work

In the event of a profile becoming damaged in service it is recommended that the damaged profile is removed and replaced to ensure full product performance.

DURABILITY

Colour Fastness

Accelerated weathering tests and natural exposure trials indicate that Kestrel products are at least as durable as conventional window grade PVC-U profiles. White Kestrel PVC-UE profiles are Kitemarked and satisfy UV stability and UV aged impact resistance requirements to BS7619:2010.

PHYSICAL PERFORMANCE

Flatness

When measured in accordance with BS7619:2010 the surface flatness over any 100mm distance does not exceed +/- 0.6mm.

Bowing

When measured in accordance with BS7619:2010 test procedure the maximum permitted bowing is 25mm over a 5 metre length. This is not applicable to products which, under their own weight, lie flat.

PHYSICAL PERFORMANCE

Dimensions (in mm)

Width (as cut)	Tolerance
----------------	-----------

0 - 50	±0.5
--------	------

51-150	±1.1
--------	------

151- 250	±1.7
----------	------

251- 350	±2.2
----------	------

Over 350	±3.3
----------	------

Thickness	Tolerance
-----------	-----------

5 -12	+/- 0.5
-------	---------

Over 12	+/- 0.75
---------	----------

Length	Tolerance
--------	-----------

5.0	- 0
-----	-----

Water Absorption

The PVC-U surface skin of Kestrel Roofline profiles is unaffected by moisture. Due to the closed cell structure of the material cut ends are non-absorbent.

Thermal Movement

Linear thermal expansion when measured to BS4370 Part 3 Method 13 is less than $7 \times 10^{-5}/^{\circ}\text{C}$ similar to that of rigid PVC-U. thermal movement.

Thermal Conductivity

Cellular foam profiles have a very low co-efficient of thermal conductivity, resulting in insulation properties better than timber boarding or gypsum plasterboard ($K=0.06W/mC$).

Chemical Resistance

Staining will result from contact with creosote or bitumen. Organic solvents and solvent based cleaning solutions will damage the surface finish.

Kestrel PVC-UE profiles are liable to damage if attacked by aromatic solvents, ketones and esters. PVC-UE profiles are resistant to insect attack but may need protection during storage from vermin.

Fire Resistance

Kestrel white cellular foam profiles do not support combustion and conform to the following specifications: Surface spread of flame BS476 Part 7 1997. Fire Propagation BS476 Part 6 1989 (see Fixing Summary table on opposite page). CE Marking requires that cladding be tested for its reaction to fire.

Kestrel PVC-UE cladding with PVC-U skin achieves a Classification of Reaction to Fire Performance: D-s3, d2/AVM. Kestrel PVC-UE cladding with PVC-U skin and Laminate Foil achieves a Classification of Reaction to Fire Performance: E.

Impact Resistance

All white Kestrel PVC-UE profiles are Kitemarked and comply with the BS specification for falling weight impact resistance as specified by BS7619:2010.

Softening Point

The foamed PVC-UE material has a softening point of approximately 75°C.

STORAGE

Profiles are protected on the co-extruded surface by polythene lo-tac film, which should be removed immediately prior to installation. Kestrel PVC-UE profiles are delivered in packs sealed in polythene sleeves, using coloured cellotape for ease of identification of the product shades. Pack quantities vary according to the profile and all packs carry a Kestrel product code indicating product, quantity and date of manufacture.

All packs not in stillages should be unloaded by hand, stored flat in their protective packaging on a clean, level surface in stacks not exceeding 1 metre high and restrained from collapse.

Where the packs are stored externally, additional protection should be provided against the weather and accidental damage. Where possible all products should be stored in doors to prevent any water ingress to the packaging and during excessively hot weather the removal of the possibility of heat build up and subsequent distortion of the product within the packaging.

B) PVC AND THE ENVIRONMENT

PVC RESIN SYNTHESIS: PVC is one of the world's oldest plastics. It has evolved since the 1940s to become a much used, cost effective, safe, adaptable and environmentally efficient material. In essence, salt and oil derivatives are combined to produce a plastic material specified for a

broad range of applications across various market sectors. Production processes are being continually improved. For this reason, the European industry, under the auspices of the European Council for Vinyl Manufacturers (ECVM), has signed a European Industry Charter, committing us all to tighter limits on emissions from PVC production plants.

PVC RESIN WASTE MANAGEMENT:

Plastics represent only 6% of municipal solid waste, of which the PVC component is about one tenth and is mainly composed of used packaging. It is known that the presence or absence of PVC in the municipal solid waste stream makes no difference to the levels of dioxins produced during incineration.

Developed countries generate some 500 kg of waste per person per annum. In the EU this represents 100 million tonnes. of household waste annually. Plastic materials account for 6%, of which PVC itself accounts for 0.6% in total, i.e. 600,000 tonnes. In Western Europe only 30% is incinerated, most going to landfill.

A study of PVC undertaken by the TNO Institute of Environmental and Energy Technology in Holland on behalf of the European Commission's Director General emphasises that PVC can be incinerated safely and cleanly.that PVC can be incinerated safely and cleanly.

REPROCESSING PVC-U AND PVC-UE:

During any manufacturing process, a small percentage of scrap is generated. Kestrel reprocesses this back into the manufacturing cycle without losing any of the excellent characteristics of our finished products. Long term durability, aesthetics, colour fastness and weather resistance are not affected. Kestrel reprocesses 99.8% of all its incoming materials. The small amount of unusable scrap is disposed of, off site, at locally authorised and registered incinerators or land fill sites.

C) STANDARDS AND CERTIFICATION

Kestrel's principal product ranges have all the necessary approvals for wide use in the majority of common domestic and commercial building applications.

British Board of Agreement

PVC-UE Roofline System: Certificate No.11/4835

PVC-UE Cladding System: Certificate No.11/4839.

BS Kitemark:

Kestrel products are manufactured in accordance with British Standard 7619: 2010. License no. KM51726.

Company Standards:

Kestrels' business and manufacturing resources have been assessed to and are operated under ISO 9001:2008, ISO 14001:2004 and BES 6001.

D) PRODUCT GUARANTEES

Kestrel's white products are guaranteed for 20 years as standard or can be extended to 35 years through our Approved Installer Scheme. All foiled profiles are guaranteed for 10 years provided that approved installation and maintenance instructions are followed. Copies of the guarantees which relate to white and foiled products are available from the Kestrel customer services on 08702 406107.

Fixing Summary

Roofline		
Expansion Gap	White	5mm per board end
	Foils & Colours	8mm per board end
Fixing	Replacement Fascia - 16mm+	2 per fixing centre, max 600mm centres, 65mm polytop nails (or 50mm x 4mm shank screws), austenitic stainless steel (grade A4 BS EN ISO 3506-1 : 2009).
	Overcap fascia - 9mm+	2 per fixing centre, max 600mm centres, 50mm polytop nails (or 40mm x 4mm shank screws), austenitic stainless steel (grade A4 BS EN ISO 3506-1 : 2009).
	Soffit	Per fixing centre, max 600mm centres, 40mm polytop pins (or 40mm x 4mm shank screws), austenitic stainless steel (grade A4 BS EN ISO 3506-1 : 2009).
Soffit Boards	Soffit wider than 300mm	Soffits up to 300mm wide require no additional fixing. Soffit boards over 300mm wide should be fixed at maximum 600mm centres along their length and 300mm centres across their width. Fix to adequate timber bearers.
Load Bearing	Fascia 16mm+	16mm - 22mm boards will support all eaves tiles in common usage in the UK (up to 10kg load per 1m length of fascia) provided that the boards are installed within the requirements of the BBA certificate.
	Fascia <16mm	All fascia less than 16mm requires a minimum 12mm exterior grade plywood backing board.
Joint Fixing		Low modulus neutral cure silicone BS5889 Type A
Gutter Fixing	For 16 - 22 mm boards	Fix gutter brackets directly into the board using, for each bracket, at least 2 x 10 gauge x 25mm long (parallel thread form) austenitic s/steel screws, ensuring that the screws penetrate the rear face of the board and that the bracket spacings do not exceed one metre.
Gutter Fixing	For 9mm boards	For the 9 mm board, gutter brackets are screwed through the fascia board onto rafter feet or other timber support.

Cladding		
Expansion Gap	White	5mm per board end
	Foils & Colours	8mm per board end
Joint Fixing		Low modulus neutral cure silicone BS5889 Type A.
Fixing Centres	White	1 per fixing centre, max 600mm centres, 25 or 30mm x 2mm shank nails, austenitic stainless steel (grade A4 BS EN ISO 3506-1 : 2009).
	Foils	1 per fixing centre, max 400mm centres, 30mm x 2mm shank nails, austenitic stainless steel (grade A4 BS EN ISO 3506-1 : 2009).
	Kavex Embossed	1 per fixing centre, max 300mm centres for twin plank, (600mm for single plank) 30mm x 2mm shank nails, austenitic stainless steel (grade A4 BS6 EN ISO 3506-1 : 2009).
Battens / Ventilation	White	19 x 38mm battens. Allow a minimum of 19mm ventilated air space behind the back of all cladding installations. This satisfies the NHBC requirement for a minimum 10mm wide ventilation cavity to be maintained between claddings and sheathing.
	Foils	50 x 38mm battens. Allow a minimum of 50mm ventilated space behind the back of all cladding installations.
	Kavex	25 x 38mm battens. Allow a minimum of 25mm ventilated air space behind the back of all cladding installations.

General		
Installation Temperature		To be installed between 5°C & 25°C temperatures

Fire Rating				
	Range	Finish	Thickness (mm)	Class
BS476 Part 7	Roofline	White	16, 18, 22	1
BS476 Part 7	Roofline	White	9, 10	1Y
BS476 Part 7	Cladding	White	6	1Y
BS476 Part 7	Cladding	White / Coloured	7	2Y
EUROCLASS BS EN 13823 & BS EN ISO 11925-2	Cladding	White / Coloured	6, 7	D-s3,d2
EUROCLASS BS EN ISO 11925-2	Cladding	Laminated Foil	6	E

Dedicated Estimating Team

Kestrel has a dedicated estimating team with over 20 year's experience.

With the ability to accept electronic and hardcopy tenders and drawings. Average turnaround time is under seven days offering 99.5% accuracy and they are able to schedule from drawings or pricing bill of quantities. This service is free of charge.

All electronic drawings should be e-mailed to:
spec@kestrelbce.co.uk

All paper drawings should be posted directly sent to:

Kestrel Estimating Department
Billet Lane,
Normanby Enterprise Park,
Normanby Road,
Scunthorpe,
North Lincolnshire,
DN15 9YH.

Specification Tel: 01724 400 454
Specification Fax: 01724 280 241
Specification email: spec@kestrelbce.co.uk

Kestrel Customer Services

Tel: 08702 406107 or 08702 406197
Email: info@kestrelbce.co.uk



April 2018



www.kbp.co.uk

KESTREL
rely on it